

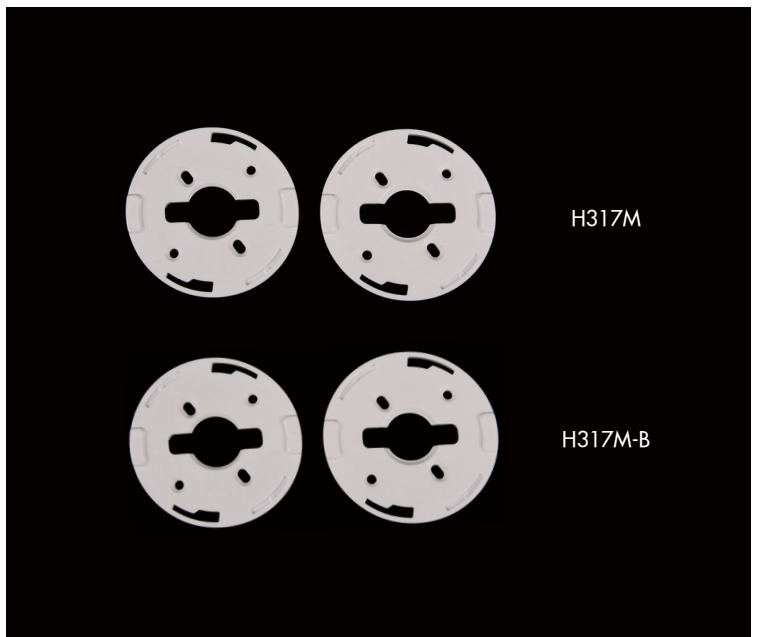



规格/TECHNICAL SPECIFICATIONS

型号/MODEL NUMBER:	I LENS146-C0B75-15-H
透镜尺寸/LENS DIMENSIONS:	Φ75.0*46.0MM
支架尺寸/HOLDER DIMENSIONS:	Φ75.0*48.55MM
定位方式/FASTENING:	锁螺丝/Screw
是否符合ROHS/ROHS COMPLIANT:	是/YES



Holder Part No./支架零件号	Colour /颜色	Specification/规格	Matched led/匹配光源	Fastening/固定
H316M	Black/黑色		/	Clips 卡扣
H317M	White/白色		*Holder matched leds/支架匹配光源: CREE: 1816/1820/1830	Screw 锁螺丝
H317M-B	White/白色		*Holder matched leds/支架匹配光源: Luminus CXM-11 19*19	Screw 锁螺丝

说明/CHARACTERISTIC:

- 透镜有多种不同的配光角度。
The lens have multiple types beam angles.
- 不同的支架来匹配不同LED, 锁螺丝定位安装。
With different types brackets to match different leds, Screw positioning.
- 兼容多种灯珠。
Compatible with various led beads.
- 适用于室内照明。
Suitable for indoor lighting.
- 与市面上同类镜头相比, 光效更好, 光斑更漂亮, 兼容性更好, 特别是非常低的炫光值。
Compared with similar type lenses on the market, with higher efficiency, more beautiful spot and better compatibility.
Anti-glare lens with very low UGR

I LENS146-COB75-15-H

实测配光/OPTICAL RESULTS (PMMA)

LED: Bridgelux LES 12MM
半角 (50%) / FWHM: 16.4°
全角 (10%) / FWTM: 29.1°
光效 / Efficiency: 111.77%
眩光值 / UGR: 6.2
灯光颜色 / Light colour: 白色 / White

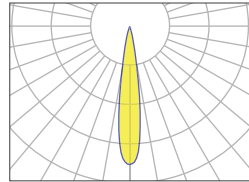

LED: Bridgelux LES 14MM
半角 (50%) / FWHM: 18.9°
全角 (10%) / FWTM: 34.1°
光效 / Efficiency: 99.09%
眩光值 / UGR: 8.4
灯光颜色 / Light colour: 白色 / White

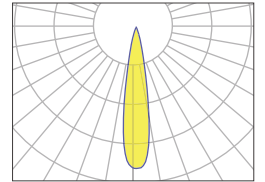

I LENS146-COB75-15-H316M-317M

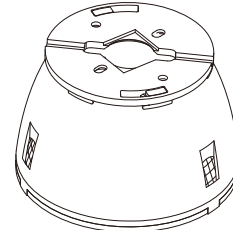
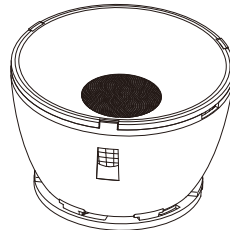
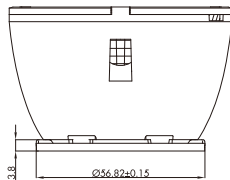
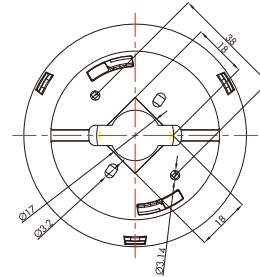
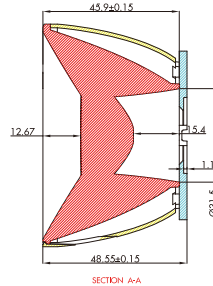
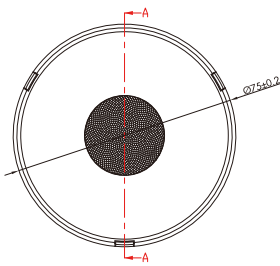

*Holder matched leds/支架匹配光源:
CREE: 1816/1820/1830

GENERAL TOLERANCES ISO2768-M (UNLESS STATED) 一般公差ISO 2768-M (除非另有说明)	MATERIAL 材质	PMMA/PC	注意/NOTE: 1. 镜片表面应光滑无划痕、气泡、凹痕和黑点。 The surface of the lens should be smooth without scratches, bubbles, dents and black spots.	
LINEAR/线性	0~5±0.05		5~10±0.1	10~30±0.15
ANGULAR/角度	0°~10°±1°		10°~50°±0.5°	50°~120°±0.3°

ILENS146-COB75-15-H

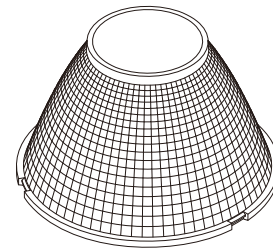
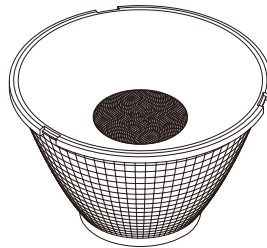
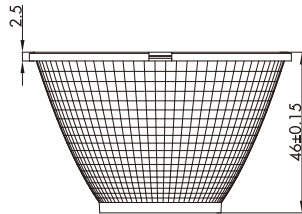
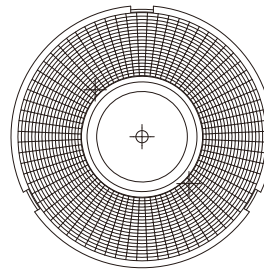
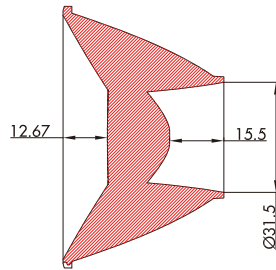
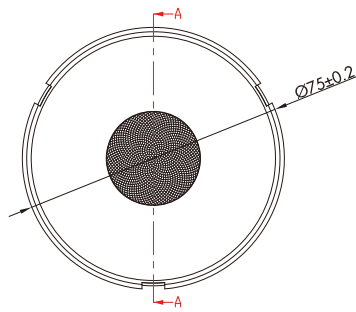

GENERAL TOLERANCES ISO2768-M (UNLESS STATED) 一般公差ISO 2768-M(除非另有说明)	MATERIAL 材质	PMMA	注意/NOTE: 1. 镜片表面应光滑无划痕、气泡、凹痕和黑点。 The surface of the lens should be smooth without scratches, bubbles, dents and black spots.	
LINEAR/线性	0~5±0.05	5~10±0.1	10~30±0.15	
ANGULAR/角度	0°~10°±1°	10°~50°±0.5°	50°~120°±0.3°	

H316M

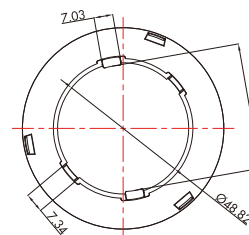
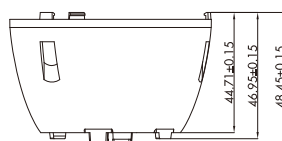
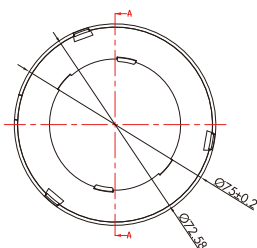
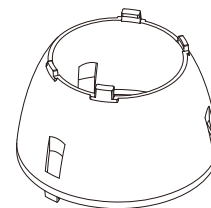
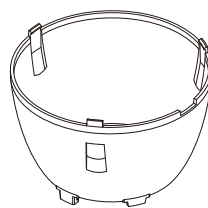
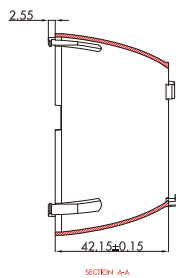

GENERAL TOLERANCES ISO2768-M (UNLESS STATED) 一般公差ISO 2768-M(除非另有说明)	MATERIAL 材质	PC		
LINEAR/线性	0~5±0.05	5~10±0.1	10~30±0.15	
ANGULAR/角度	0°~10°±1°	10°~50°±0.5°	50°~120°±0.3°	

H317M

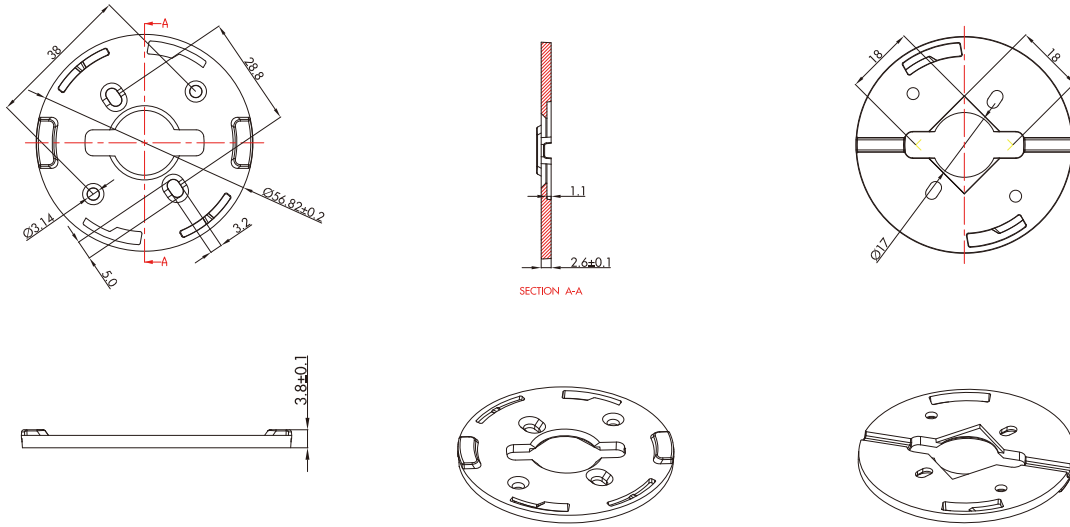

*Holder matched leds/支架匹配光源:

CREE: 1816/1820/1830

GENERAL TOLERANCES ISO2768-M (UNLESS STATED) 一般公差ISO 2768-M(除非另有说明)	MATERIAL 材质	PC		
LINEAR/线性	0~5±0.05		5~10±0.1	10~30±0.15
ANGULAR/角度	0°~10°±1°		10°~50°±0.5°	50°~120°±0.3°

H317M-B

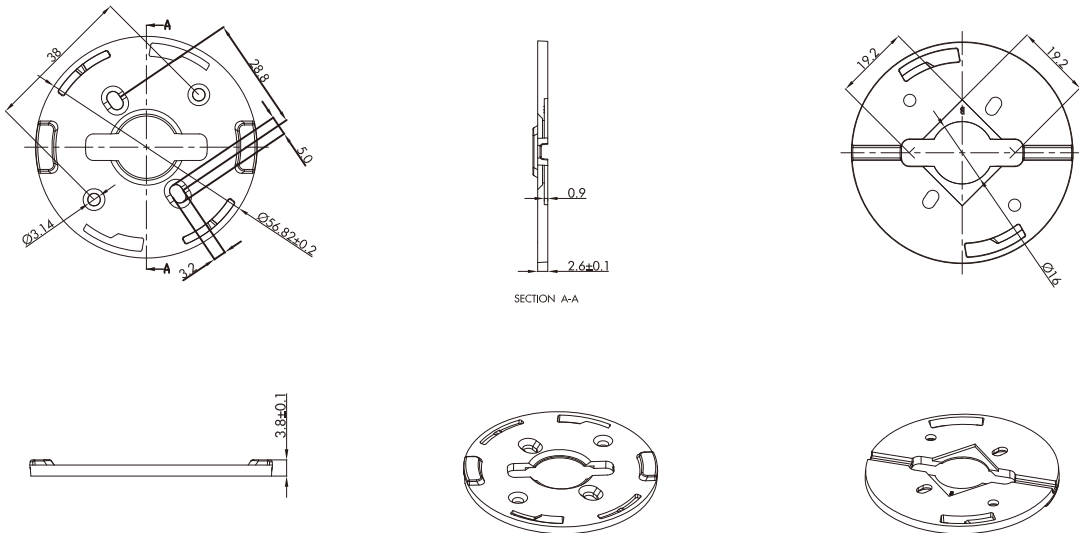

*Holder matched leds/支架匹配光源:

Luminus CXM-11 19*19

GENERAL TOLERANCES ISO2768-M (UNLESS STATED) 一般公差ISO 2768-M(除非另有说明)	MATERIAL 材质	PC		
LINEAR/线性	0~5±0.05		5~10±0.1	10~30±0.15
ANGULAR/角度	0°~10°±1°		10°~50°±0.5°	50°~120°±0.3°

产品包装/Products Packaging

Part NO.	QTY
ILENS146-C0B75-15-H	72pcs
吸塑/Blister-380*300	6pcs
外盒/Cardboard Box-395*312*395	1pcs

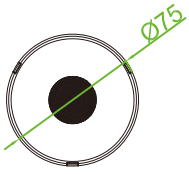

ILENS146

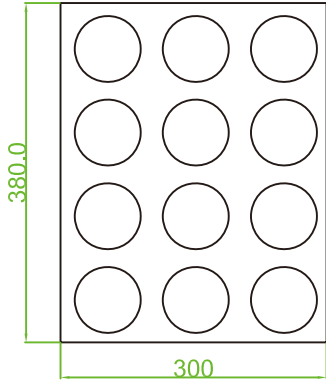

吸塑
Blister-380*300

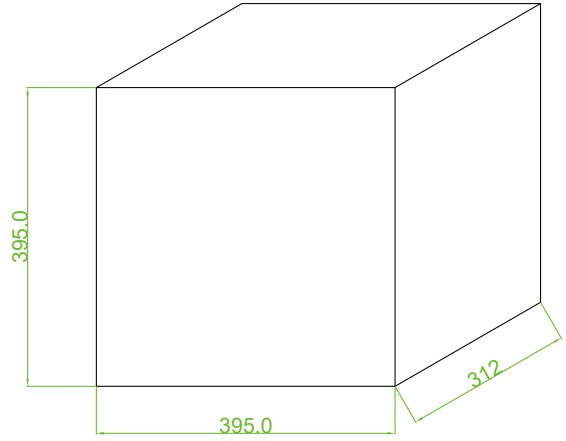

外盒
Cardboard Box-395*312*395

示意图/The schematic diagram:

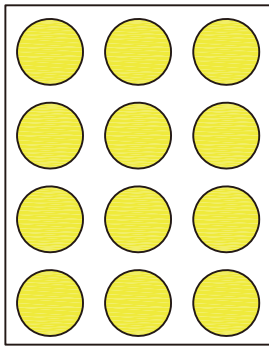

3pcs*4=12pcs

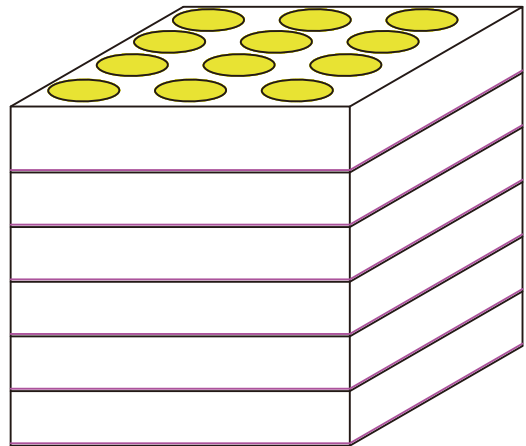

12pcs*6=72pcs