

规格/TECHNICAL SPECIFICATIONS

型号/MODEL NUMBER:	I LENS796-R17371-T5-12H1-NH-S
透镜尺寸/LENS DIMENSIONS:	173.0*71.4*5.2MM
定位方式/FASTENING:	锁螺丝、定位柱/Screw or Pin
是否符合ROHS/ROHS COMPLIANT:	是/YES

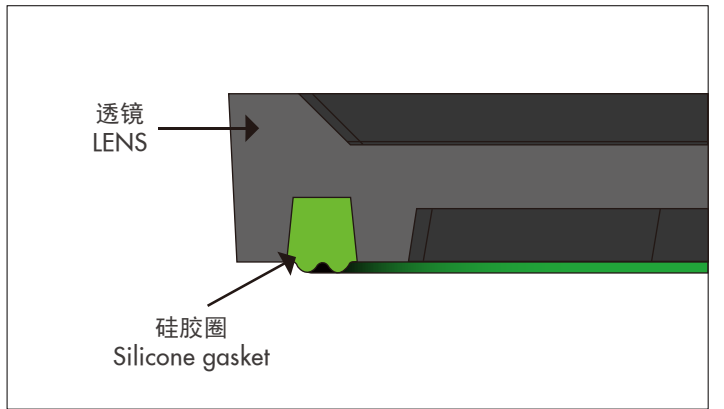
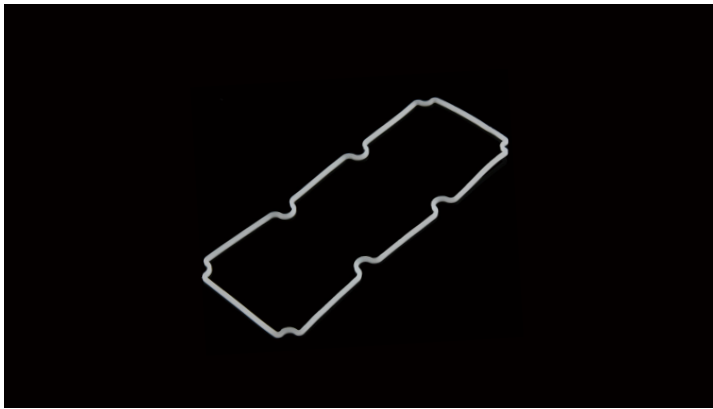
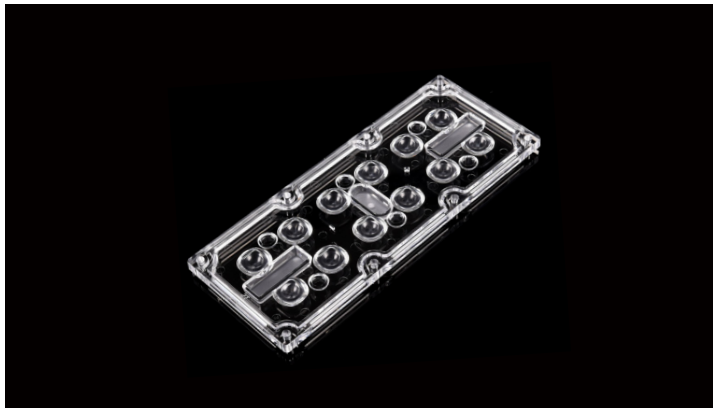
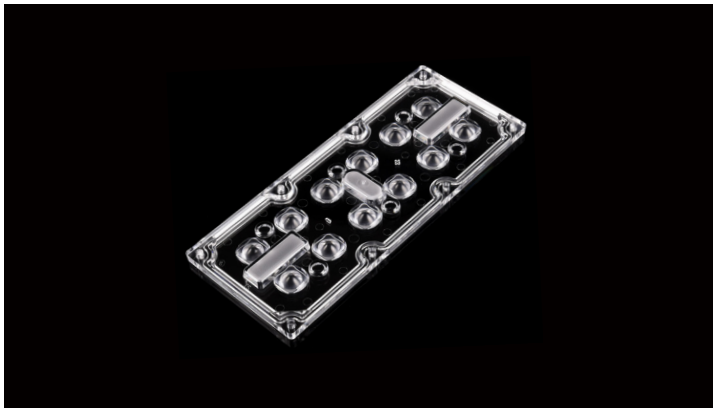

说明/CHARACTERISTIC:

1. 透镜有多种不同的配光角度。
The lens have multiple types beam angles.
2. 一体化透镜配硅胶圈。
Silicone gasket available for waterproof.
3. 兼容多种灯珠。
Compatible with various lamp beads.
4. 适用于街灯和景观灯。
Suitable for street light and landscape light.
5. I LENS229升级, 光效更好, 光斑更漂亮, 兼容性更好。
I LENS229 upgrade, better light effect, more beautiful spot and better compatibility.

ILENS796-R17371-T5-12H1-NH-S

实测配光/OPTICAL RESULTS (PC)

LED:CREE 5050
 角度/FWHM:140°*140°
 光效/Efficiency:95%
 峰值强度/Peakintensity:0.28CD/LM
 光学面数量/LED/each optic:12
 灯光颜色/Light colour:白色/White
 所需组件/Required components:

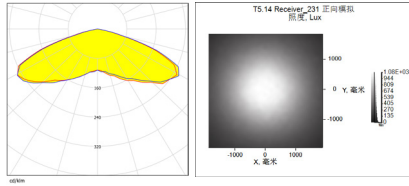

LED:CREE XML2
 角度/FWHM:140°*140°
 光效/Efficiency:95%
 峰值强度/Peakintensity:0.29CD/LM
 光学面数量/LED/each optic:12
 灯光颜色/Light colour:白色/White
 所需组件/Required components:

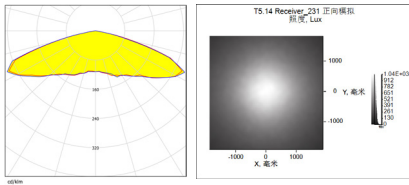

LED:LUXEON 5050 Square
 角度/FWHM:140°*140°
 光效/Efficiency:95%
 峰值强度/Peakintensity:0.31CD/LM
 光学面数量/LED/each optic:12
 灯光颜色/Light colour:白色/White
 所需组件/Required components:

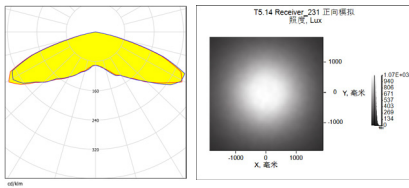

LED:LUXEON 5050 Round
 角度/FWHM:140°*140°
 光效/Efficiency:95%
 峰值强度/Peakintensity:0.28CD/LM
 光学面数量/LED/each optic:12
 灯光颜色/Light colour:白色/White
 所需组件/Required components:

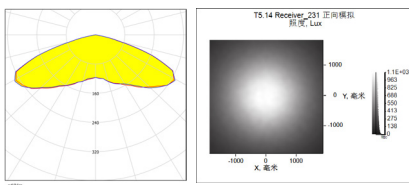

LED:LUXEON 4x3030 Round
 角度/FWHM:143°*143°
 光效/Efficiency:94%
 峰值强度/Peakintensity:0.25CD/LM
 光学面数量/LED/each optic:12
 灯光颜色/Light colour:白色/White
 所需组件/Required components:

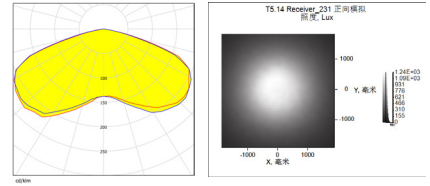

LED:SAMSUNG LH351C
 角度/FWHM:140°*140°
 光效/Efficiency:95%
 峰值强度/Peakintensity:0.33CD/LM
 光学面数量/LED/each optic:12
 灯光颜色/Light colour:白色/White
 所需组件/Required components:

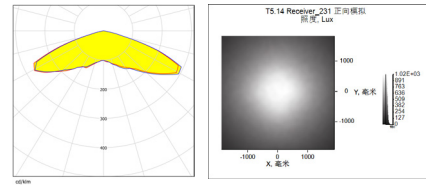

LED:SAMSUNG LH502C
 角度/FWHM:141°*141°
 光效/Efficiency:95%
 峰值强度/Peakintensity:0.28CD/LM
 光学面数量/LED/each optic:12
 灯光颜色/Light colour:白色/White
 所需组件/Required components:

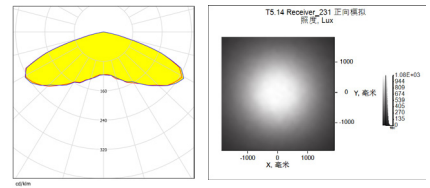

LED:OSRAM S8
 角度/FWHM:150°*150°
 光效/Efficiency:94%
 峰值强度/Peakintensity:0.22CD/LM
 光学面数量/LED/each optic:12
 灯光颜色/Light colour:白色/White
 所需组件/Required components:

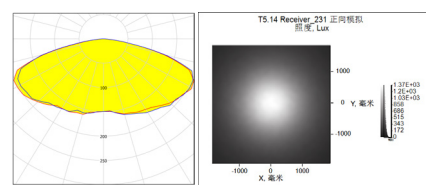

ILENS796-R17371-T5-12H1-NH-S

实测配光/OPTICAL RESULTS (PMMA)

LED:CREE 5050
 角度/FWHM:140°*140°
 光效/Efficiency:96%
 峰值强度/Peakintensity:0.27CD/LM
 光学面数量/LED/each optic:12
 灯光颜色/Light colour:白色/White
 所需组件/Required components:

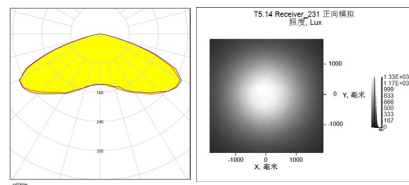

LED:CREE XML2
 角度/FWHM:142°*142°
 光效/Efficiency:96%
 峰值强度/Peakintensity:0.28CD/LM
 光学面数量/LED/each optic:12
 灯光颜色/Light colour:白色/White
 所需组件/Required components:

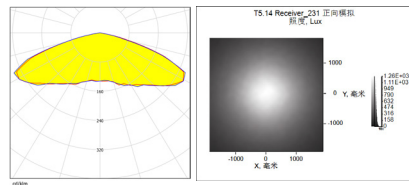

LED:LUXEON 5050 Square
 角度/FWHM:140°*140°
 光效/Efficiency:96%
 峰值强度/Peakintensity:0.27CD/LM
 光学面数量/LED/each optic:12
 灯光颜色/Light colour:白色/White
 所需组件/Required components:

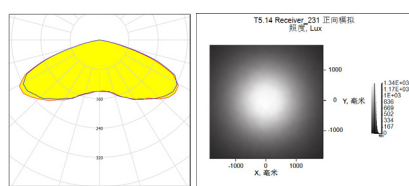

LED:LUXEON 5050 Round
 角度/FWHM:140°*140°
 光效/Efficiency:96%
 峰值强度/Peakintensity:0.27CD/LM
 光学面数量/LED/each optic:12
 灯光颜色/Light colour:白色/White
 所需组件/Required components:

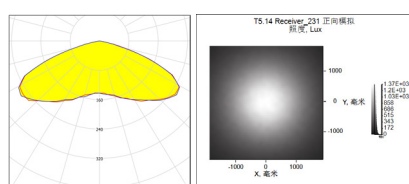

LED:LUXEON 4x3030 Round
 角度/FWHM:140°*140°
 光效/Efficiency:96%
 峰值强度/Peakintensity:0.25CD/LM
 光学面数量/LED/each optic:12
 灯光颜色/Light colour:白色/White
 所需组件/Required components:

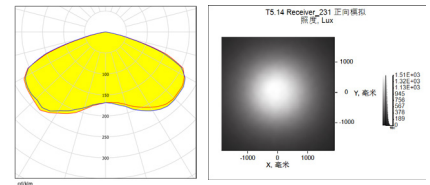

LED:SAMSUNG LH351C
 角度/FWHM:139°*139°
 光效/Efficiency:96%
 峰值强度/Peakintensity:0.32CD/LM
 光学面数量/LED/each optic:12
 灯光颜色/Light colour:白色/White
 所需组件/Required components:

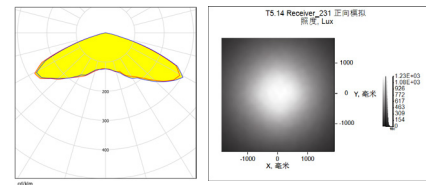

LED:SAMSUNG LH502C
 角度/FWHM:140°*140°
 光效/Efficiency:96%
 峰值强度/Peakintensity:0.27CD/LM
 光学面数量/LED/each optic:12
 灯光颜色/Light colour:白色/White
 所需组件/Required components:

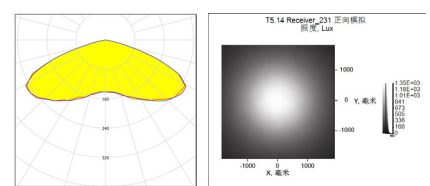

LED:OSRAM S8
 角度/FWHM:150°*150°
 光效/Efficiency:96%
 峰值强度/Peakintensity:0.22CD/LM
 光学面数量/LED/each optic:12
 灯光颜色/Light colour:白色/White
 所需组件/Required components:

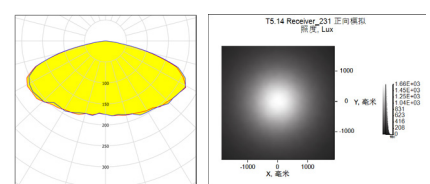

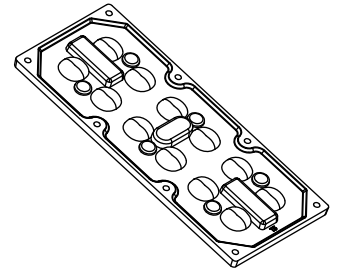
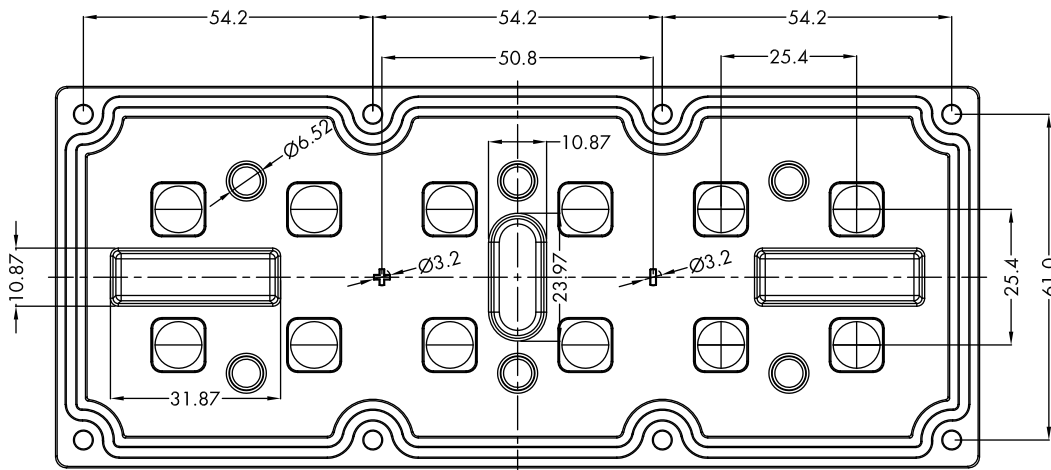
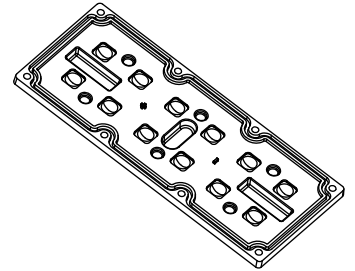
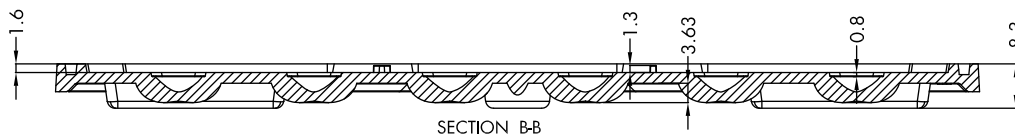
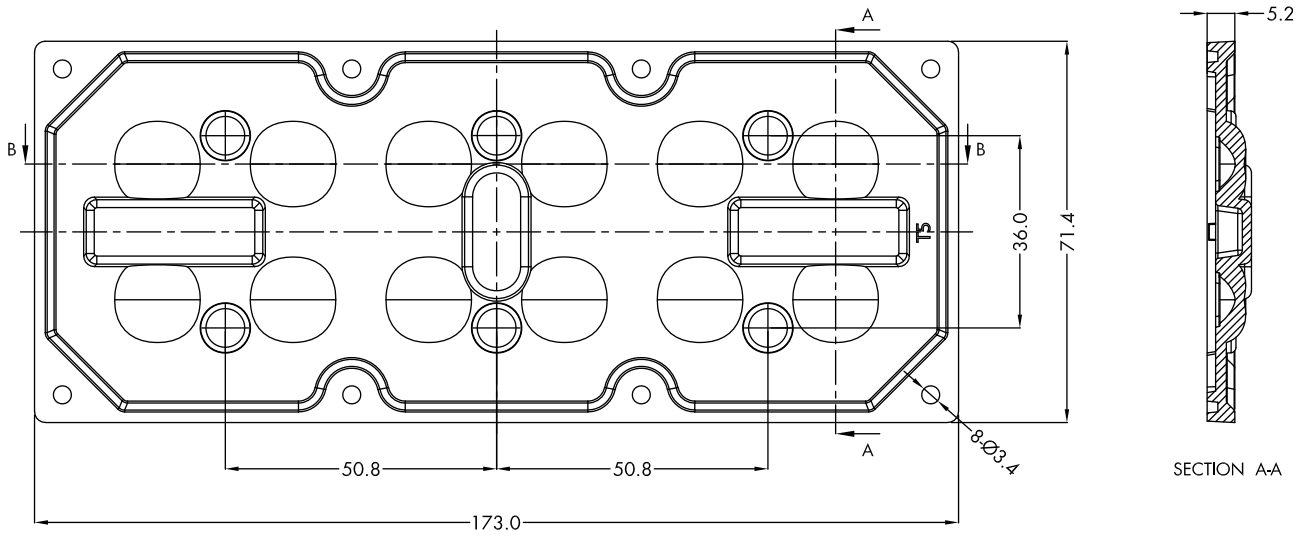

注意/NOTE:

1. 镜片表面应光滑无划痕、气泡、凹痕和黑点。

The surface of the lens should be smooth without scratches, bubbles, dents and black spots.

GENERAL TOLERANCES ISO2768-M (UNLESS STATED) 一般公差ISO 2768-M(除非另有说明)	MATERIAL 材质	PMMA or PC	DRAWING TITLE 绘图标题	I LENS796-R17371-T5-12H1-NH-S
LINEAR/线性	0~5±0.05	5~10±0.1	10~30±0.15	
ANGULAR/角度	0°~10°±1°	10°~50°±0.5°	50°~120°±0.3°	

产品包装/PRODUCTS PACKAGING

型号/Part No.	数量/QTY
ILENS796-R17371-T5-12H1-NH-S	250pcs
吸塑/Blister-380*380*20	25pcs
外盒/Cardboard box(M)	1pcs

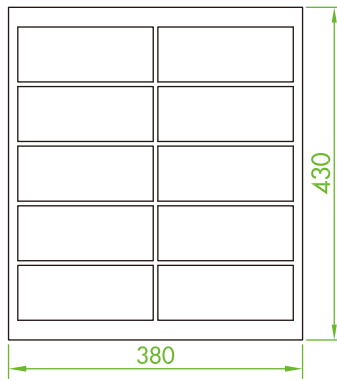

吸塑/Blister-380*380*20

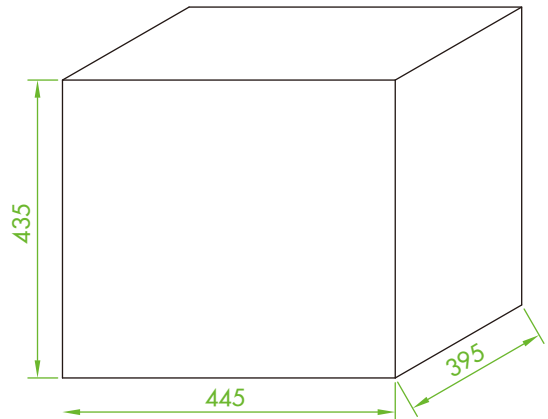

外盒/Cardboard box(M)

示意图/The schematic diagram :

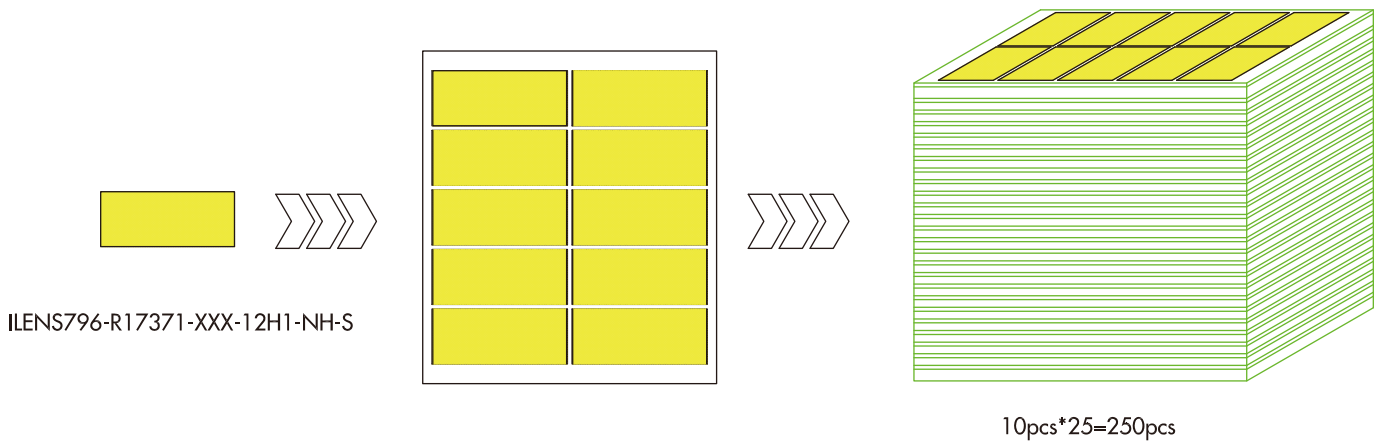

备注：防水硅胶圈是单独包装的
PS: The waterproof rubber ring is packaged separately.