

规格/TECHNICAL SPECIFICATIONS

型号/MODEL NUMBER:	I LENS796-R17371-9090-12H1-NH-S
透镜尺寸/LENS DIMENSIONS:	173.0*71.4*10.1MM
定位方式/FASTENING:	锁螺丝、定位柱/Screw or Pin
是否符合ROHS/ROHS COMPLIANT:	是/YES

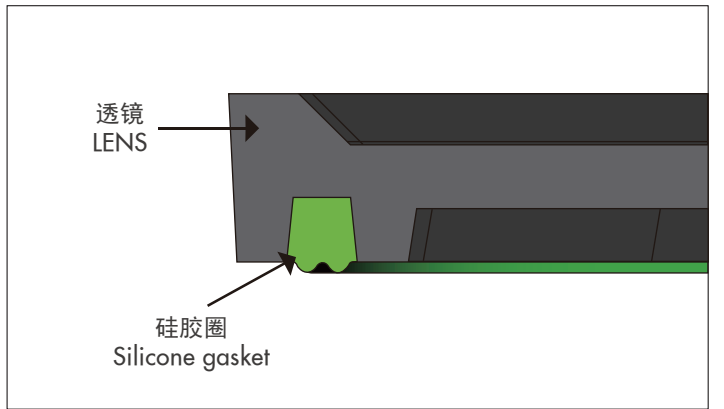
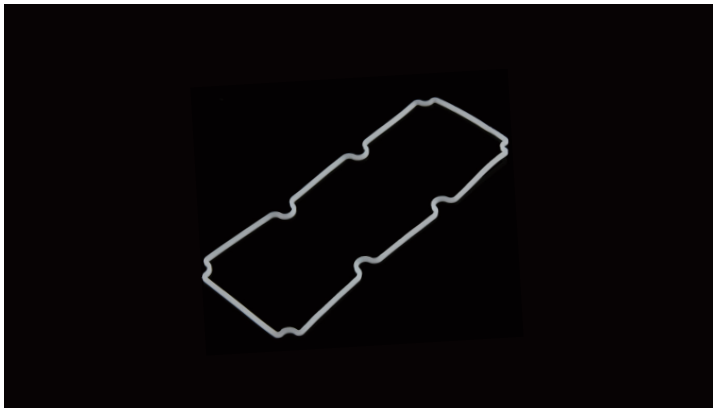
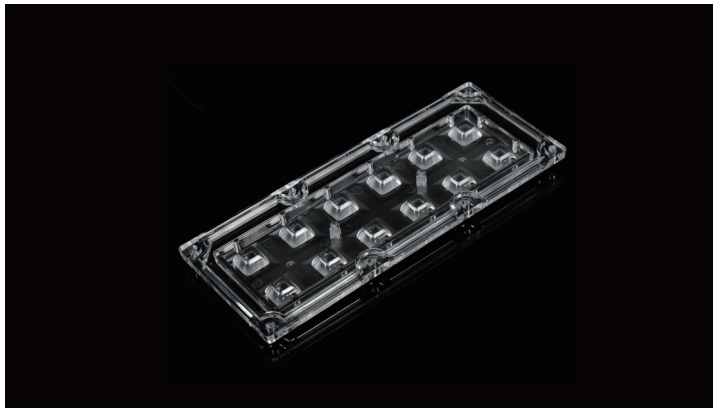

说明/CHARACTERISTIC:

1. 透镜有多种不同的配光角度。
The lens have multiple types beam angles.
2. 一体化透镜配硅胶圈。
Silicone gasket available for waterproof.
3. 兼容多种灯珠。
Compatible with various lamp beads.
4. 适用于球场灯、投光灯。
Suitable for Stadium light, flood light.
5. I LENS229升级, 光效更好, 光斑更漂亮, 兼容性更好。
I LENS229 upgrade, better light effect, more beautiful spot and better compatibility.

LED:CREE XPG3
 角度/FWHM:107°
 光效/Efficiency:84%
 峰值强度/Peakintensity:0.36CD/LM
 光学面数量/LED/each optic:12
 灯光颜色/Light colour:白色/White
 所需组件/Required components:

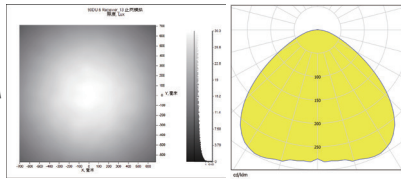

LED:CREE XML3
 角度/FWHM:109°
 光效/Efficiency:84%
 峰值强度/Peakintensity:0.34CD/LM
 光学面数量/LED/each optic:12
 灯光颜色/Light colour:白色/White
 所需组件/Required components:

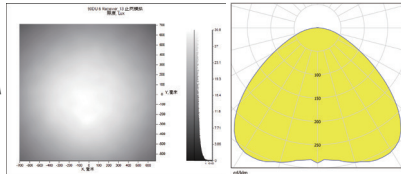

LED:CREE XD16
 角度/FWHM:95°
 光效/Efficiency:87%
 峰值强度/Peakintensity:0.43CD/LM
 光学面数量/LED/each optic:12
 灯光颜色/Light colour:白色/White
 所需组件/Required components:

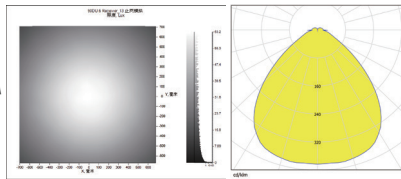

LED:LUXEON 3030 2D
 角度/FWHM:94°
 光效/Efficiency:87%
 峰值强度/Peakintensity:0.45CD/LM
 光学面数量/LED/each optic:12
 灯光颜色/Light colour:白色/White
 所需组件/Required components:

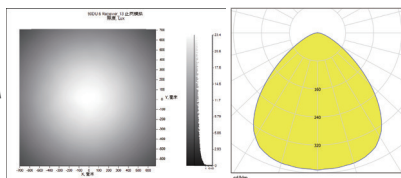

LED:LUXEON 5050
 角度/FWHM:90°
 光效/Efficiency:86%
 峰值强度/Peakintensity:0.49CD/LM
 光学面数量/LED/each optic:12
 灯光颜色/Light colour:白色/White
 所需组件/Required components:

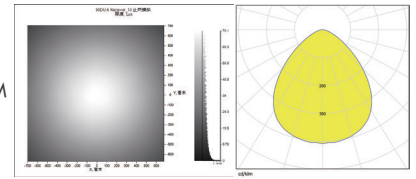

LED:LUXEON TX
 角度/FWHM:99°
 光效/Efficiency:90%
 峰值强度/Peakintensity:0.41CD/LM
 光学面数量/LED/each optic:12
 灯光颜色/Light colour:白色/White
 所需组件/Required components:

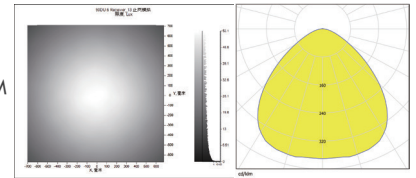

LED:SAMSUNG LH351B
 角度/FWHM:108°
 光效/Efficiency:85%
 峰值强度/Peakintensity:0.36CD/LM
 光学面数量/LED/each optic:12
 灯光颜色/Light colour:白色/White
 所需组件/Required components:

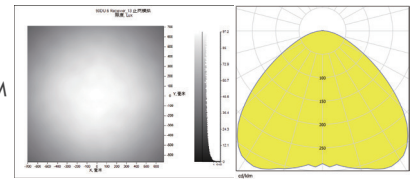

LED:OSRAM 3737
 角度/FWHM:98°
 光效/Efficiency:86%
 峰值强度/Peakintensity:0.42CD/LM
 光学面数量/LED/each optic:12
 灯光颜色/Light colour:白色/White
 所需组件/Required components:

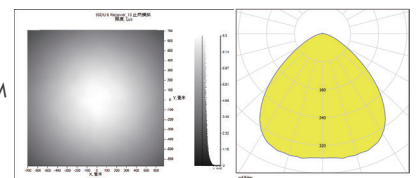

LED:CREE XPG3
 角度/FWHM:102°
 光效/Efficiency:92%
 峰值强度/Peakintensity:0.39CD/LM
 光学面数量/LED/each optic:12
 灯光颜色/Light colour:白色/White
 所需组件/Required components:

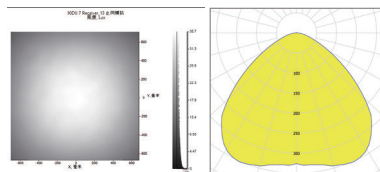

LED:CREE XML3
 角度/FWHM:103°
 光效/Efficiency:90%
 峰值强度/Peakintensity:0.37CD/LM
 光学面数量/LED/each optic:12
 灯光颜色/Light colour:白色/White
 所需组件/Required components:

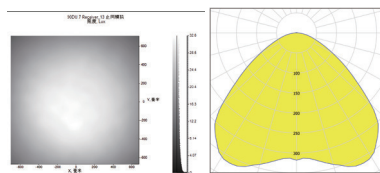

LED:CREE XD16
 角度/FWHM:92°
 光效/Efficiency:95%
 峰值强度/Peakintensity:0.45CD/LM
 光学面数量/LED/each optic:12
 灯光颜色/Light colour:白色/White
 所需组件/Required components:

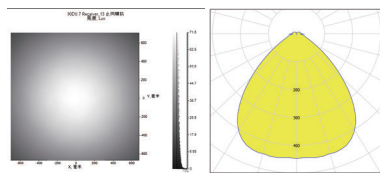

LED:LUXEON 3030 2D
 角度/FWHM:91°
 光效/Efficiency:95%
 峰值强度/Peakintensity:0.48CD/LM
 光学面数量/LED/each optic:12
 灯光颜色/Light colour:白色/White
 所需组件/Required components:

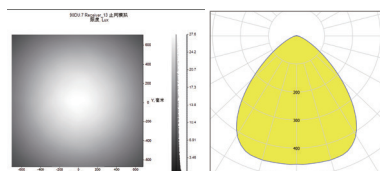

LED:LUXEON 5050
 角度/FWHM:87°
 光效/Efficiency:94%
 峰值强度/Peakintensity:0.51CD/LM
 光学面数量/LED/each optic:12
 灯光颜色/Light colour:白色/White
 所需组件/Required components:

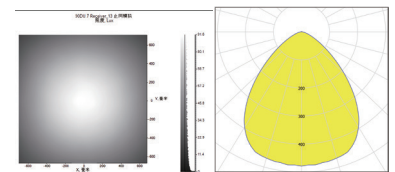

LED:LUXEON TX
 角度/FWHM:95°
 光效/Efficiency:94%
 峰值强度/Peakintensity:0.44CD/LM
 光学面数量/LED/each optic:12
 灯光颜色/Light colour:白色/White
 所需组件/Required components:

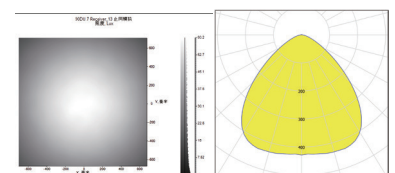

LED:SAMSUNG LH351B
 角度/FWHM:100°
 光效/Efficiency:92%
 峰值强度/Peakintensity:0.39CD/LM
 光学面数量/LED/each optic:12
 灯光颜色/Light colour:白色/White
 所需组件/Required components:

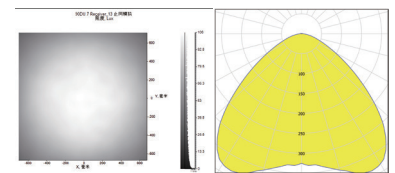

LED:OSRAM 3737
 角度/FWHM:95°
 光效/Efficiency:94%
 峰值强度/Peakintensity:0.45CD/LM
 光学面数量/LED/each optic:12
 灯光颜色/Light colour:白色/White
 所需组件/Required components:

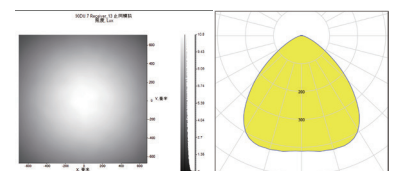

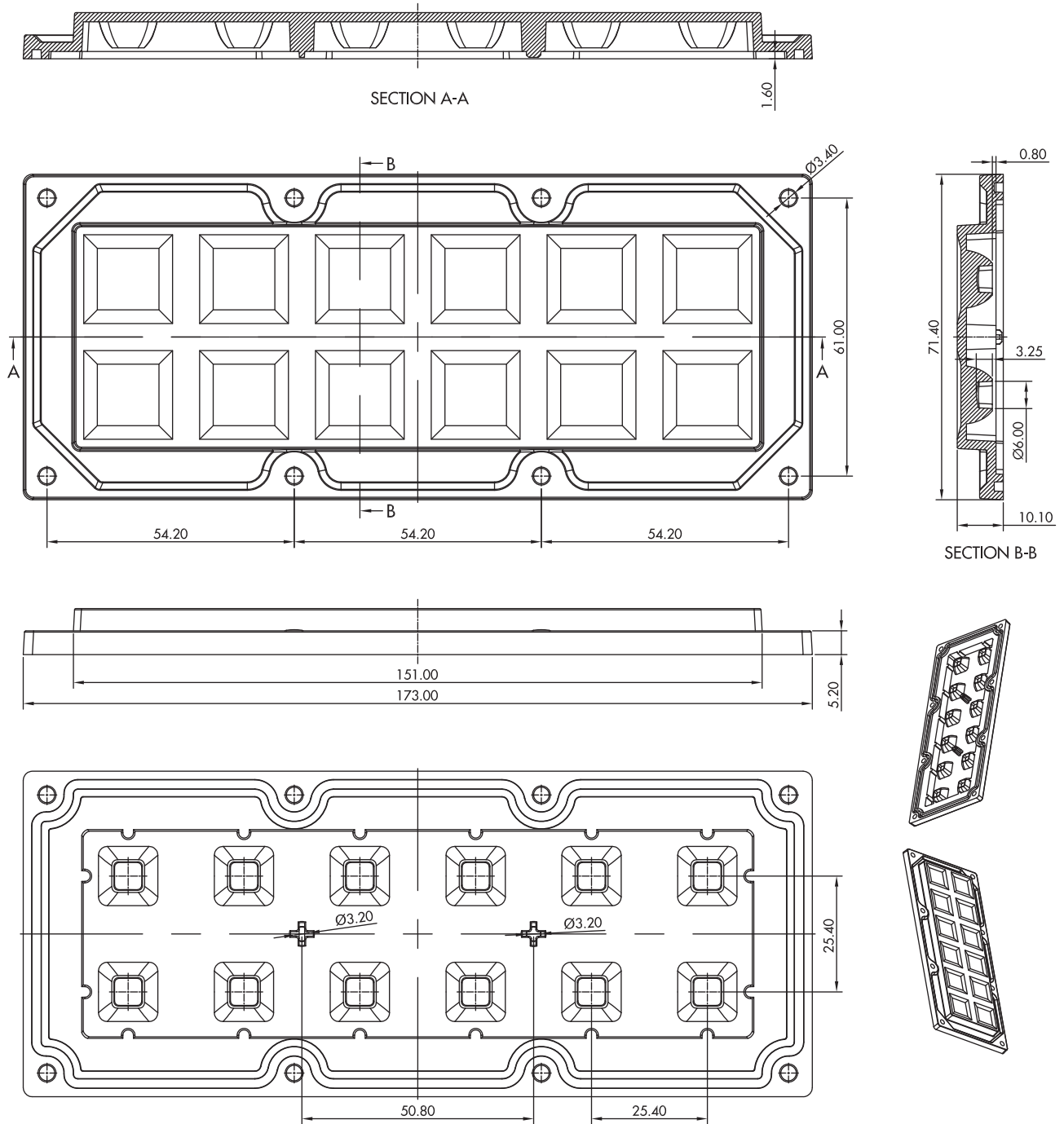

注意/NOTE:

1. 镜片表面应光滑无划痕、气泡、凹痕和黑点。

The surface of the lens should be smooth without scratches, bubbles, dents and black spots.

GENERAL TOLERANCES ISO2768-M (UNLESS STATED) 一般公差ISO 2768-M (除非另有说明)	MATERIAL 材质	PMMA or PC	DRAWING TITLE 绘图标题	ILENS796-R17371-9090-12H1-NH-S
LINEAR/线性	0~5±0.05		5~10±0.1	10~30±0.15
ANGULAR/角度	0°~10°±1°		10°~50°±0.5°	50°~120°±0.3°

产品包装/PRODUCTS PACKAGING

型号/Part No.	数量/QTY
ILENS796-R17371-9090-12H1-NH-S	250pcs
吸塑/Blister-380*380*20	25pcs
外盒/Cardboard box(M)	1pcs

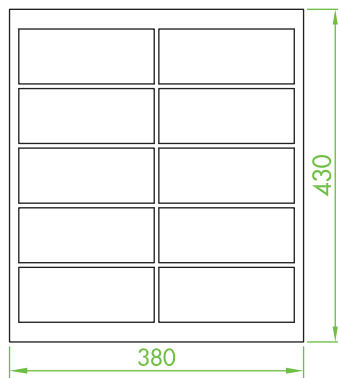

吸塑/Blister-380*380*20

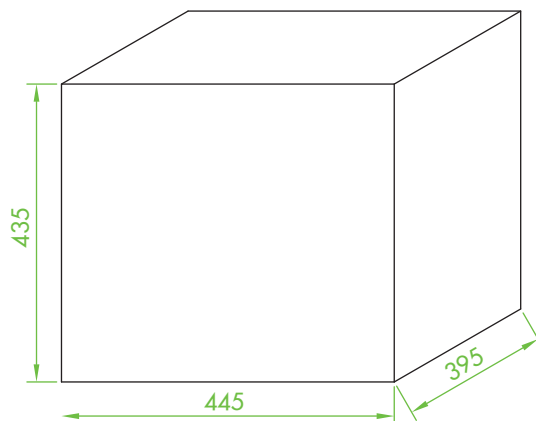

外盒/Cardboard box(M)

示意图/The schematic diagram :

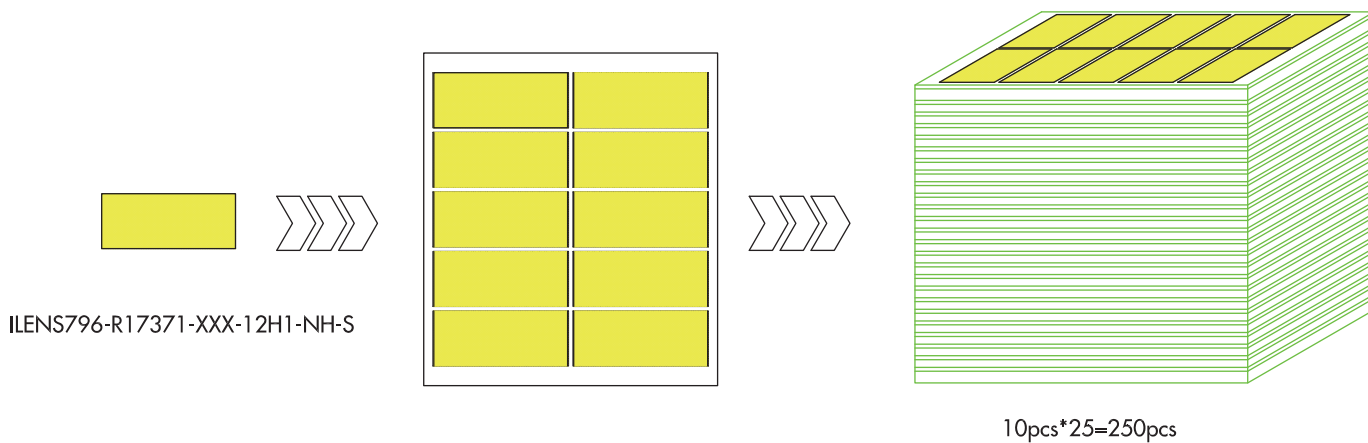

备注：防水硅胶圈是单独包装的
PS: The waterproof rubber ring is packaged separately.