

规格/TECHNICAL SPECIFICATIONS

型号/MODEL NUMBER:	I LENS900-S100100-60-36H1-NH-S
尺寸/DIMENSIONS:	100.0*100.0MM
高度/HEIGHT:	10.4MM
定位方式/FASTENING:	锁螺丝/Screw
是否符合ROHS/ROHS COMPLIANT:	是/YES

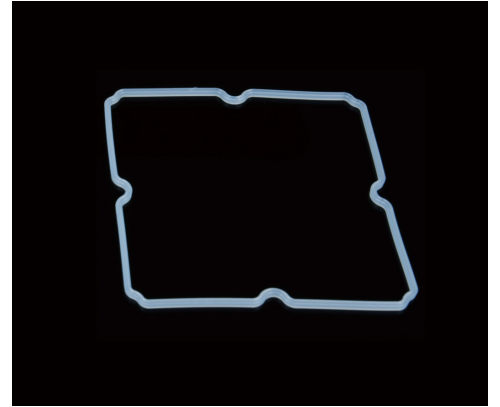
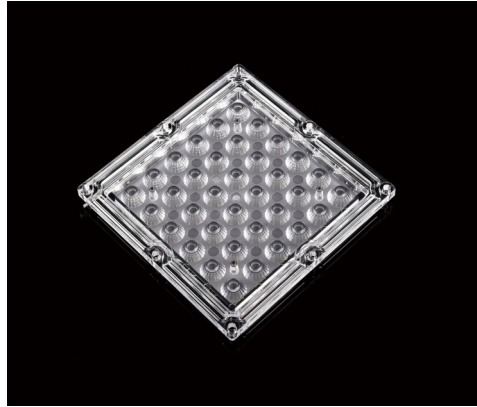
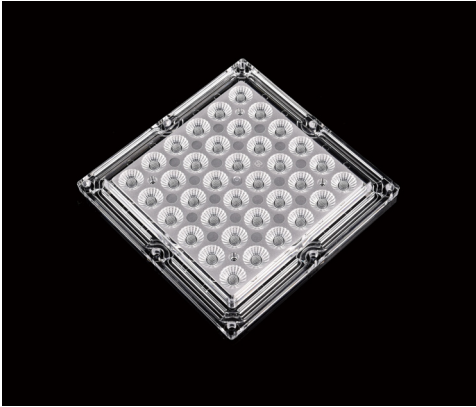

说明/CHARACTERISTIC:

1. 透镜有1种配光角度。
The lens has one light distribution angle.
2. 一体化透镜配硅胶圈。
Silicone gasket available for waterproof.
3. 兼容各种灯珠。
Compatible with various lamp beads.
4. 适用于球场灯、投光灯。
Suitable for Stadium light, flood light.
5. 与市面上同类镜头相比, 光效更好, 光斑更漂亮, 兼容性更好。
Compared with similar lenses on the market, the light effect is better, the spot is more beautiful, and the compatibility is better.

LED:CREE XPE2
 角度/FWHM:71.5°
 光效/Efficiency:92%
 峰值强度/Peakintensity:0.76CD/LM
 光学面数量/LED/each optic:36
 灯光颜色/Light colour:白色/White
 所需组件/Required components:

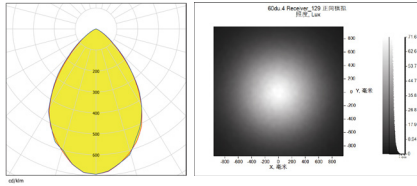

LED:CREE XPG2
 角度/FWHM:71.6°
 光效/Efficiency:92%
 峰值强度/Peakintensity:0.73CD/LM
 光学面数量/LED/each optic:36
 灯光颜色/Light colour:白色/White
 所需组件/Required components:

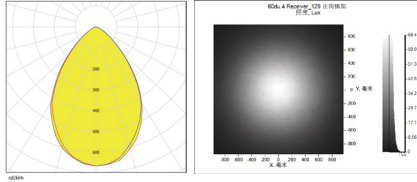

LED:CREE 3030
 角度/FWHM:57.1°
 光效/Efficiency:91%
 峰值强度/Peakintensity:1.03CD/LM
 光学面数量/LED/each optic:36
 灯光颜色/Light colour:白色/White
 所需组件/Required components:

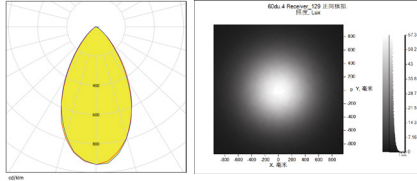

LED:LUXEON 3030 Round
 角度/FWHM:58°
 光效/Efficiency:90%
 峰值强度/Peakintensity:1.02CD/LM
 光学面数量/LED/each optic:36
 灯光颜色/Light colour:白色/White
 所需组件/Required components:

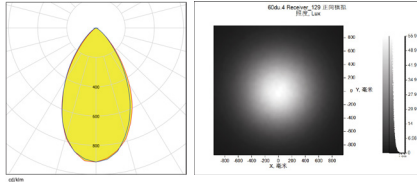

LED:LUXEON 3030 Square
 角度/FWHM:58.3°
 光效/Efficiency:91%
 峰值强度/Peakintensity:0.99CD/LM
 光学面数量/LED/each optic:36
 灯光颜色/Light colour:白色/White
 所需组件/Required components:

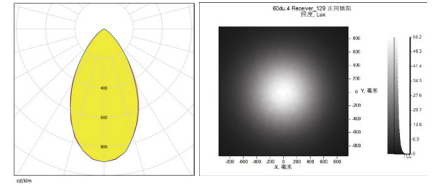

LED:SAMSUNG LH351B
 角度/FWHM:67°
 光效/Efficiency:92%
 峰值强度/Peakintensity:0.78CD/LM
 光学面数量/LED/each optic:36
 灯光颜色/Light colour:白色/White
 所需组件/Required components:

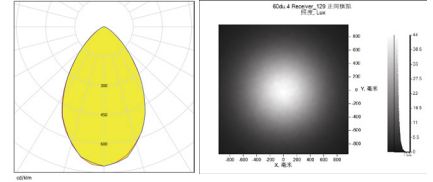

LED:SAMSUNG LM281B
 角度/FWHM:59.4°
 光效/Efficiency:91%
 峰值强度/Peakintensity:0.99CD/LM
 光学面数量/LED/each optic:36
 灯光颜色/Light colour:白色/White
 所需组件/Required components:

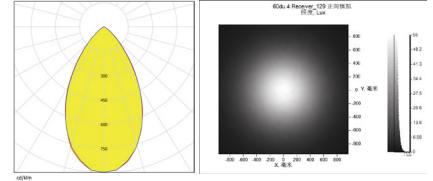

LED:OSRAM GW_PSLR31em
 角度/FWHM:70.6°
 光效/Efficiency:92%
 峰值强度/Peakintensity:0.74CD/LM
 光学面数量/LED/each optic:36
 灯光颜色/Light colour:白色/White
 所需组件/Required components:

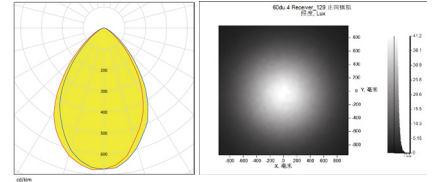

LED:CREE XPE2
 角度/FWHM:65.6°
 光效/Efficiency:96%
 峰值强度/Peakintensity:0.87CD/LM
 光学面数量/LED/each optic:36
 灯光颜色/Light colour:白色/White
 所需组件/Required components:

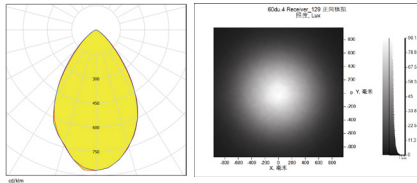

LED:CREE XPG2
 角度/FWHM:65.7°
 光效/Efficiency:96%
 峰值强度/Peakintensity:0.83CD/LM
 光学面数量/LED/each optic:36
 灯光颜色/Light colour:白色/White
 所需组件/Required components:

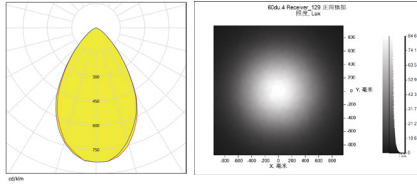

LED:CREE 3030
 角度/FWHM:52.9°
 光效/Efficiency:96%
 峰值强度/Peakintensity:1.19CD/LM
 光学面数量/LED/each optic:36
 灯光颜色/Light colour:白色/White
 所需组件/Required components:

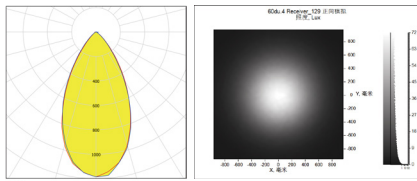

LED:LUXEON 3030 Round
 角度/FWHM:53.8°
 光效/Efficiency:95%
 峰值强度/Peakintensity:1.18CD/LM
 光学面数量/LED/each optic:36
 灯光颜色/Light colour:白色/White
 所需组件/Required components:

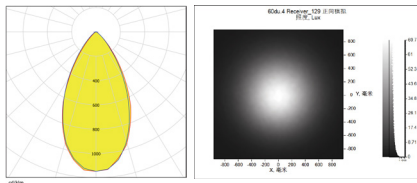

LED:LUXEON 3030 Square
 角度/FWHM:54°
 光效/Efficiency:96%
 峰值强度/Peakintensity:1.14CD/LM
 光学面数量/LED/each optic:36
 灯光颜色/Light colour:白色/White
 所需组件/Required components:

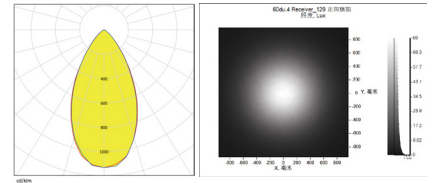

LED:SAMSUNG LH351B
 角度/FWHM:61.7°
 光效/Efficiency:96%
 峰值强度/Peakintensity:0.9CD/LM
 光学面数量/LED/each optic:36
 灯光颜色/Light colour:白色/White
 所需组件/Required components:

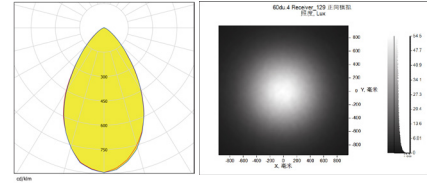

LED:SAMSUNG LM281B
 角度/FWHM:55°
 光效/Efficiency:96%
 峰值强度/Peakintensity:1.14CD/LM
 光学面数量/LED/each optic:36
 灯光颜色/Light colour:白色/White
 所需组件/Required components:

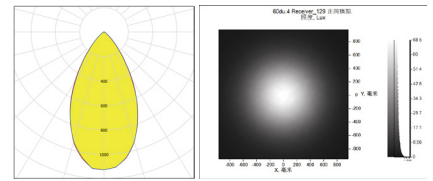

LED:OSRAM GW_PSLR31em
 角度/FWHM:64.6°
 光效/Efficiency:96%
 峰值强度/Peakintensity:0.85CD/LM
 光学面数量/LED/each optic:36
 灯光颜色/Light colour:白色/White
 所需组件/Required components:

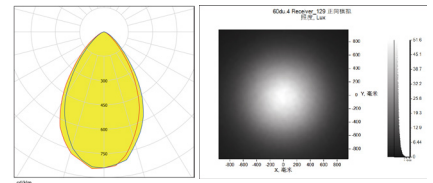

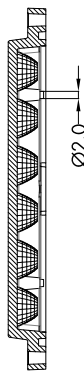
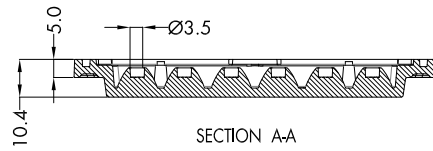
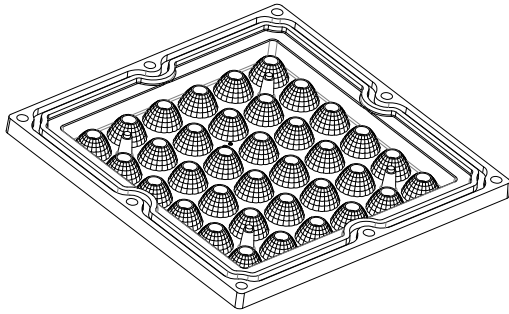
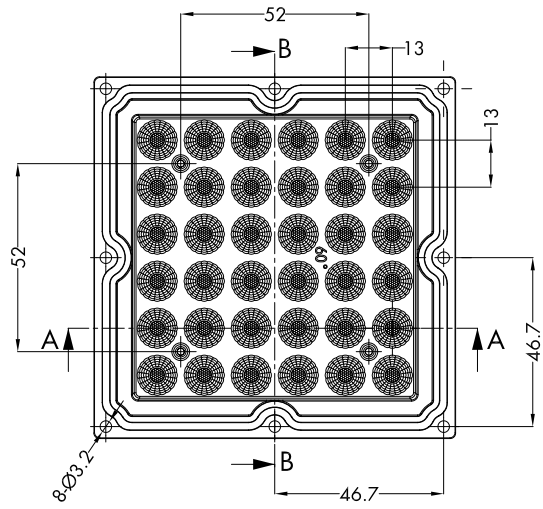
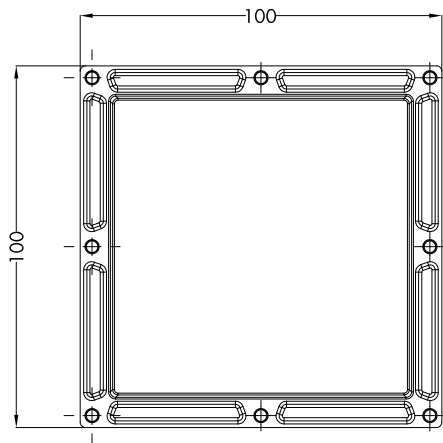

SECTION B-B

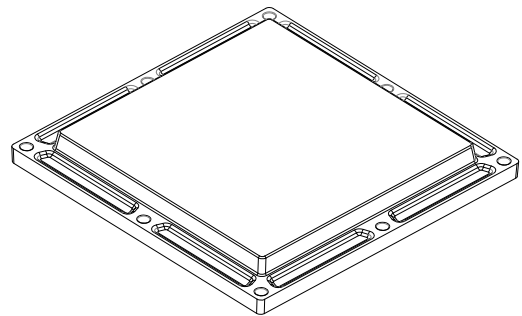

注意/NOTE:

1. 镜片表面应光滑无划痕、气泡、凹痕和黑点。

The surface of the lens should be smooth without scratches, bubbles, dents and black spots.

GENERAL TOLERANCES ISO2768-M (UNLESS STATED) 一般公差ISO 2768-M(除非另有说明)	MATERIAL 材质	PC/PMMA	DRAWING TITLE 绘图标题	I LENS900-S100100-60-36H1-NH-S		
LINEAR/线性	0.5 $\leq X \leq 3.0$	± 0.1	3.0 $\leq X \leq 6.0$	± 0.1	6.0 $\leq X \leq 30.0$	± 0.2
ANGULAR/角度	0° $\leq X \leq 10^\circ$	$\pm 0.1^\circ$	10° $\leq X \leq 50^\circ$	$\pm 30'$	50° $\leq X \leq 120^\circ$	$\pm 20'$

产品包装/PRODUCTS PACKAGING

Part NO.	QTY
ILENS900	300pcs
吸塑/Blister-A(B)-470*360*25	25pcs
外盒/Cardboard Box-485*375*325	1pcs

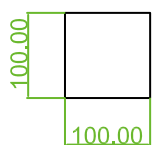

ILENS900

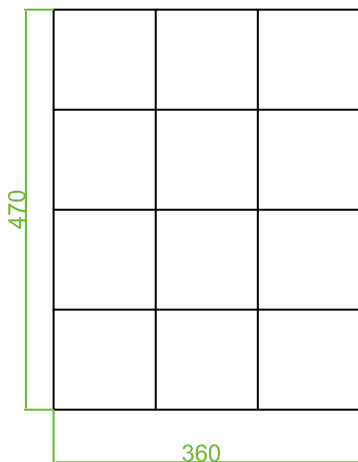

吸塑
Blister-A(B)-470*360*25

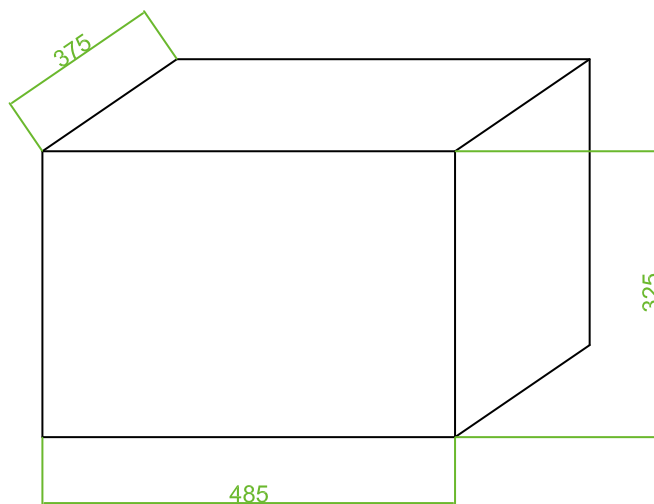

外盒
Cardboard Box-485*375*325

示意图/The schematic diagram:

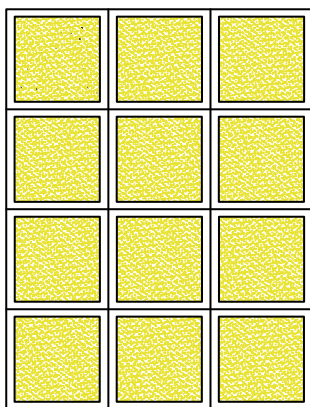

3pcs*4=12pcs

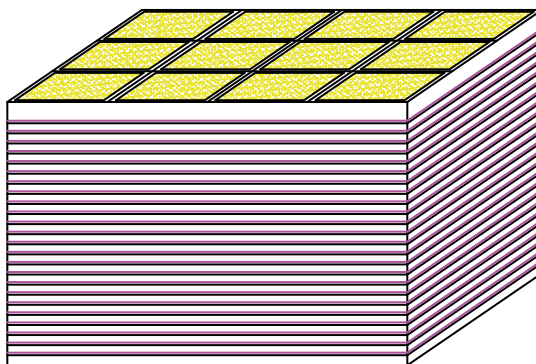

12pcs*25=300pcs