

## 规格/TECHNICAL SPECIFICATIONS

型号/MODEL NUMBER:	I LENS849-R5050-60T-16H1-NH
透镜尺寸/LENS DIMENSIONS:	49.50*49.50*5.99MM
定位方式/FASTENING:	锁螺丝、定位柱/Screw or Pin
是否符合ROHS/ROHS COMPLIANT:	是/YES



### 说明/CHARACTERISTIC:

1. 透镜有多种不同的配光角度。  
The lens has two different light distribution angles, Other different light distribution products are being developed according to market conditions.
2. 一体化透镜不需要支架和硅胶圈。  
Integrated lens eliminates the need for holders and silicone gaskets.
3. 兼容各种灯珠。  
Compatible with various lamp beads.
4. 适用于洗墙灯、投光灯。  
Suitable for wall washer, flood light.
5. 与市面上同类镜头相比, 光效更好, 光斑更漂亮, 兼容性更好。  
Compared with similar lenses on the market, the light effect is better, the spot is more beautiful, and the compatibility is better.

# ILENS849-R5050-60T-16H1-NH

# 实测配光/OPTICAL RESULTS (PC)

LED:CREE XPE2  
 角度/FWHM:60.8°  
 光效/Efficiency:95%  
 峰值强度/Peakintensity:0.76CD/LM  
 光学面数量/LED/each optic:16  
 灯光颜色/Light colour:白色/White  
 所需组件/Required components:

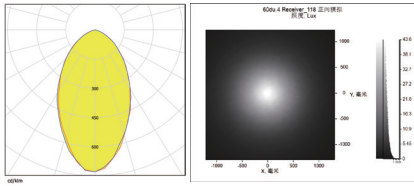

LED:CREE XPL2  
 角度/FWHM:75.4°  
 光效/Efficiency:95%  
 峰值强度/Peakintensity:0.61CD/LM  
 光学面数量/LED/each optic:16  
 灯光颜色/Light colour:白色/White  
 所需组件/Required components:

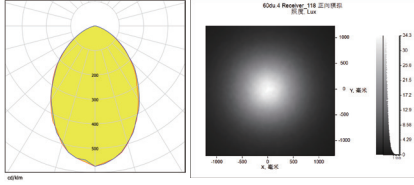

LED:LUXEON 3030 Round  
 角度/FWHM:58.3°  
 光效/Efficiency:94%  
 峰值强度/Peakintensity:0.77CD/LM  
 光学面数量/LED/each optic:16  
 灯光颜色/Light colour:白色/White  
 所需组件/Required components:

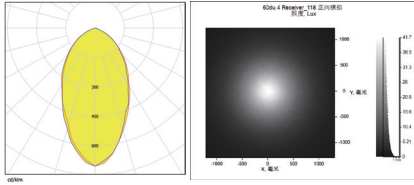

LED:LUXEON 3030 Square  
 角度/FWHM:61.6°  
 光效/Efficiency:95%  
 峰值强度/Peakintensity:0.73CD/LM  
 光学面数量/LED/each optic:16  
 灯光颜色/Light colour:白色/White  
 所需组件/Required components:

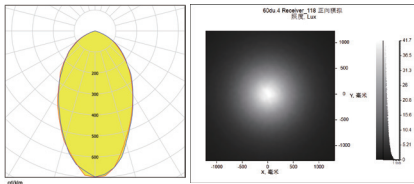

LED:LUXEON 5050 Round  
 角度/FWHM:61.7°  
 光效/Efficiency:93%  
 峰值强度/Peakintensity:0.73CD/LM  
 光学面数量/LED/each optic:16  
 灯光颜色/Light colour:白色/White  
 所需组件/Required components:

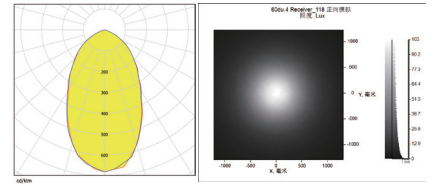

LED:SAMSUNG LM281B  
 角度/FWHM:58.2°  
 光效/Efficiency:95%  
 峰值强度/Peakintensity:0.79CD/LM  
 光学面数量/LED/each optic:16  
 灯光颜色/Light colour:白色/White  
 所需组件/Required components:

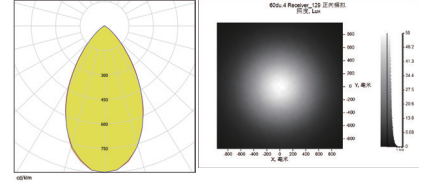

LED:OSRAM GH\_CSSRM4\_24  
 角度/FWHM:68.4°  
 光效/Efficiency:95%  
 峰值强度/Peakintensity:0.68CD/LM  
 光学面数量/LED/each optic:16  
 灯光颜色/Light colour:白色/White  
 所需组件/Required components:

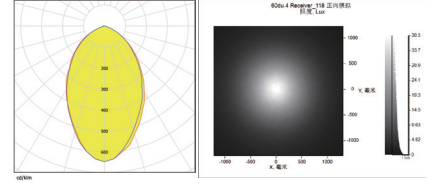

LED:OSRAM GW\_PSLR31em  
 角度/FWHM:58.7°  
 光效/Efficiency:95%  
 峰值强度/Peakintensity:0.77CD/LM  
 光学面数量/LED/each optic:16  
 灯光颜色/Light colour:白色/White  
 所需组件/Required components:

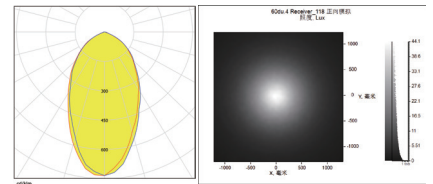

# ILENS849-R5050-60T-16H1-NH

# 实测配光/OPTICAL RESULTS (PMMA)

LED:CREE XPE2  
 角度/FWHM:67°  
 光效/Efficiency:96%  
 峰值强度/Peakintensity:0.67CD/LM  
 光学面数量/LED/each optic:16  
 灯光颜色/Light colour:白色/White  
 所需组件/Required components:

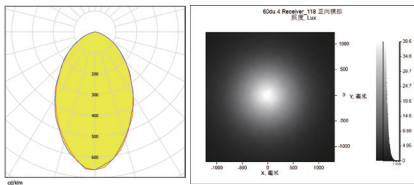

LED:CREE XPL2  
 角度/FWHM:81°  
 光效/Efficiency:96%  
 峰值强度/Peakintensity:0.55CD/LM  
 光学面数量/LED/each optic:16  
 灯光颜色/Light colour:白色/White  
 所需组件/Required components:

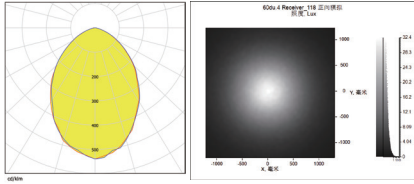

LED:LUXEON 3030 Round  
 角度/FWHM:64.6°  
 光效/Efficiency:96%  
 峰值强度/Peakintensity:0.68CD/LM  
 光学面数量/LED/each optic:16  
 灯光颜色/Light colour:白色/White  
 所需组件/Required components:

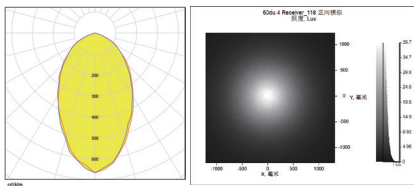

LED:LUXEON 3030 Square  
 角度/FWHM:68.6°  
 光效/Efficiency:96%  
 峰值强度/Peakintensity:0.73CD/LM  
 光学面数量/LED/each optic:16  
 灯光颜色/Light colour:白色/White  
 所需组件/Required components:

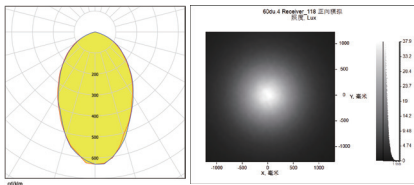

LED:LUXEON 5050 Round  
 角度/FWHM:65.4°  
 光效/Efficiency:96%  
 峰值强度/Peakintensity:0.68CD/LM  
 光学面数量/LED/each optic:16  
 灯光颜色/Light colour:白色/White  
 所需组件/Required components:

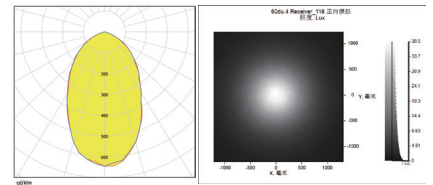

LED:SAMSUNG LM281B  
 角度/FWHM:64.8°  
 光效/Efficiency:96%  
 峰值强度/Peakintensity:0.69CD/LM  
 光学面数量/LED/each optic:16  
 灯光颜色/Light colour:白色/White  
 所需组件/Required components:

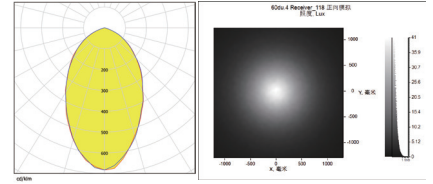

LED:OSRAM GH\_CSSRM4\_24  
 角度/FWHM:74.9°  
 光效/Efficiency:96%  
 峰值强度/Peakintensity:0.6CD/LM  
 光学面数量/LED/each optic:16  
 灯光颜色/Light colour:白色/White  
 所需组件/Required components:

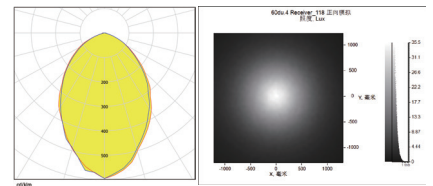

LED:OSRAM GW\_PSLR31em  
 角度/FWHM:65.5°  
 光效/Efficiency:96%  
 峰值强度/Peakintensity:0.67CD/LM  
 光学面数量/LED/each optic:16  
 灯光颜色/Light colour:白色/White  
 所需组件/Required components:

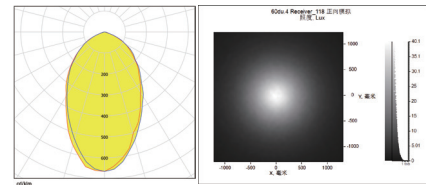

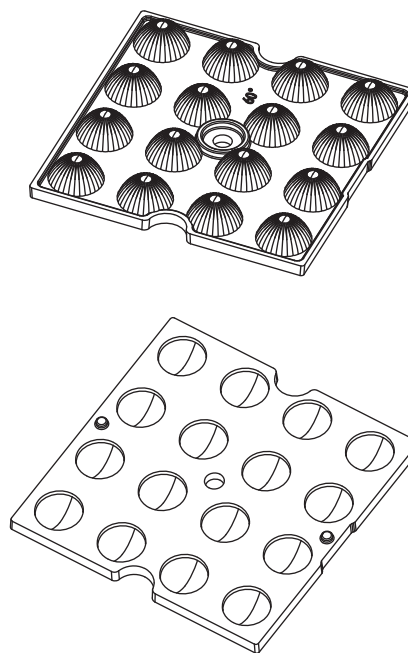
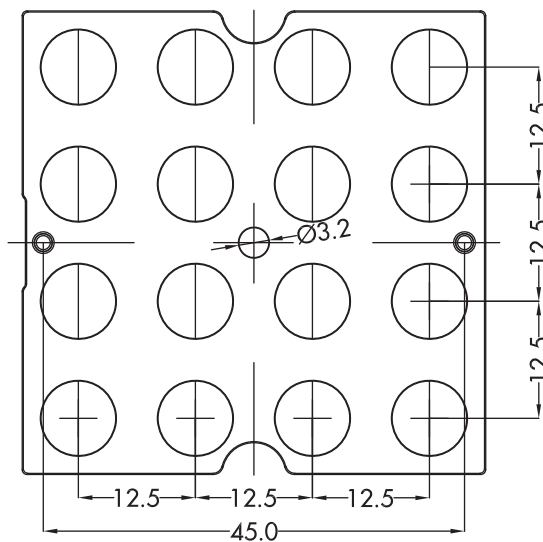
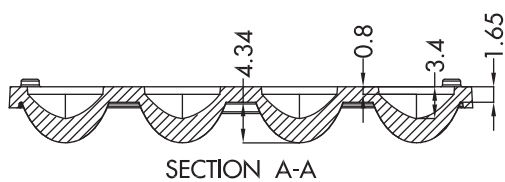
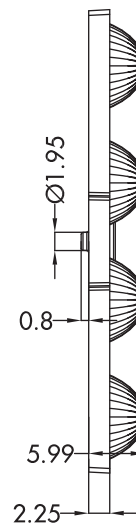
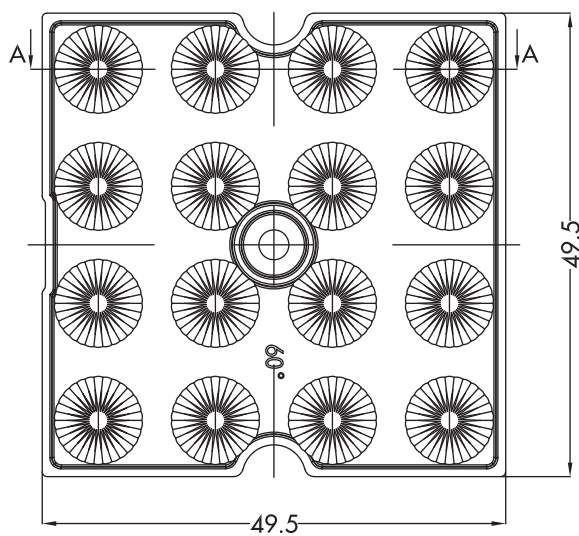

注意/NOTE:

1. 镜片表面应光滑无划痕、气泡、凹痕和黑点。

The surface of the lens should be smooth without scratches, bubbles, dents and black spots.

GENERAL TOLERANCES ISO2768-M (UNLESS STATED) 一般公差ISO 2768-M(除非另有说明)	MATERIAL 材质	PMMA or PC	DRAWING TITLE 绘图标题	ILENS849-R5050-60T-16H1-NH	
LINEAR/线性	0~5±0.05		5~10±0.1	10~30±0.15	
ANGULAR/角度	0°~10°±1°		10°~50°±0.5°	50°~120°±0.3°	

# 产品包装/PRODUCTS PACKAGING

型号/Part No.	数量/QTY
ILENS849-R5050-60T-16H1-NH	1728pcs
外盒/Cardboard -0.4mm	432pcs
外盒/Cardboard box(S)	18pcs
外盒/Cardboard box(M)	1pcs

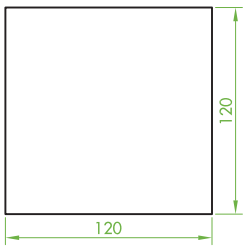

cardboard-0.4mm

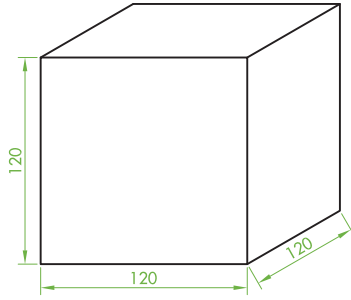

cardboard box(S)

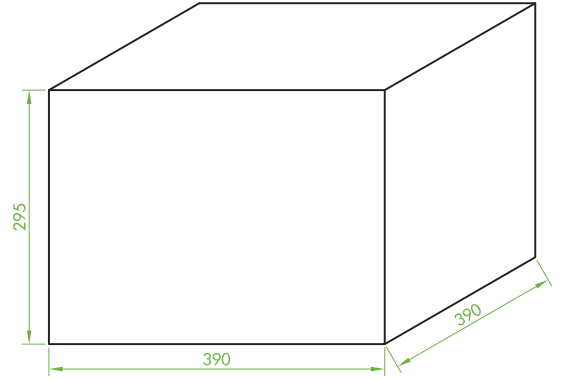

cardboard box(M) 2:1

示意图/The schematic diagram :

