

规格/TECHNICAL SPECIFICATIONS

型号/MODEL NUMBER:	I LENS222-S35-B20-H
透镜尺寸/LENS DIMENSIONS:	Φ35*17.66MM
支架尺寸/HOLDER DIMENSIONS:	Φ37*18.84MM
定位方式/FASTENING:	打胶/贴胶/定位柱/Tape or Pin
是否符合ROHS/ROHS COMPLIANT:	是/YES



Holder Part No./支架零件号	Colour /颜色	Specification/规格	Function/功能	Fastening/固定
H222V-3535	Black/黑色		Adapting 3535 LED 适配 3535 LED	Tape 打胶/贴胶
	White/白色			
H222V-5050	Black/黑色		Adapting 5050 LED 适配 5050 LED	
	White/白色			
H222V-P	Black/黑色		Adapting 3535 or 5050 LED 适配 3535 或 5050 LED	PIN 定位柱
	White/白色			
H222V-P-1	Black/黑色		Adapting 3535 or 5050 LED 适配 3535 或 5050 LED	PIN 定位柱
	White/白色			

说明/CHARACTERISTIC:

- 透镜有多种不同的配光角度。
The lens have multiple types beam angles.
- 多种不同的支架来匹配不同LED, 贴胶或者定位柱定位安装。
With different types of holders to match different leds, Self-adhesive tape or pins for fix.
- 兼容多种灯珠。
Compatible with various lamp beads.
- 适用于洗墙灯和投光灯。
Suitable for wall washing lighting and floodlights.
- 与市面上同类镜头相比, 光效更好, 光斑更漂亮, 兼容性更好。
Compared with similar type lenses on the market, with better light effect, more beautiful spot and better compatibility.

LED:CREE XPE2
 角度/FWHM:19°
 光效/Efficiency:90%
 峰值强度/Peakintensity:9CD/LM
 光学面数量/LED/each optic:1
 灯光颜色/Light colour:白色/White
 所需组件/Required components:

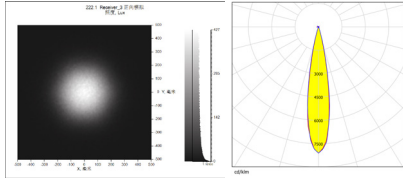

LED:LUMILEDS HL2X
 角度/FWHM:18°
 光效/Efficiency:90%
 峰值强度/Peakintensity:8CD/LM
 光学面数量/LED/each optic:1
 灯光颜色/Light colour:白色/White
 所需组件/Required components:

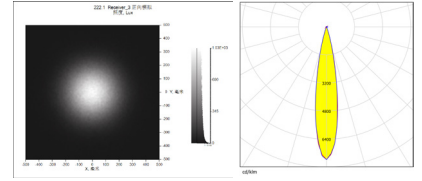

LED:CREE XPG3
 角度/FWHM:24°
 光效/Efficiency:90%
 峰值强度/Peakintensity:4CD/LM
 光学面数量/LED/each optic:1
 灯光颜色/Light colour:白色/White
 所需组件/Required components:

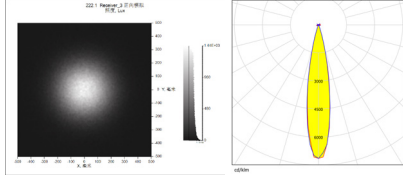

LED:LUXEON SST40
 角度/FWHM:19°
 光效/Efficiency:90%
 峰值强度/Peakintensity:7CD/LM
 光学面数量/LED/each optic:1
 灯光颜色/Light colour:白色/White
 所需组件/Required components:

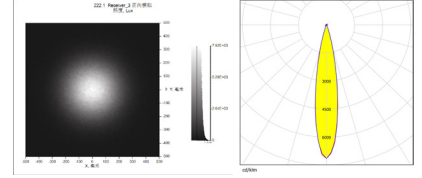

LED:SAMSUNG 351B
 角度/FWHM:19°
 光效/Efficiency:90%
 峰值强度/Peakintensity:8CD/LM
 光学面数量/LED/each optic:1
 灯光颜色/Light colour:白色/White
 所需组件/Required components:

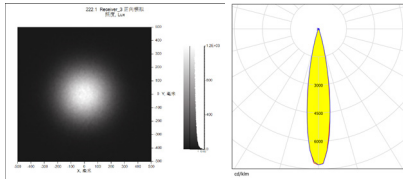

LED:添鑫 5050RGBW
 角度/FWHM:18°
 光效/Efficiency:90%
 峰值强度/Peakintensity:8CD/LM
 光学面数量/LED/each optic:1
 灯光颜色/Light colour:白色/White
 所需组件/Required components:

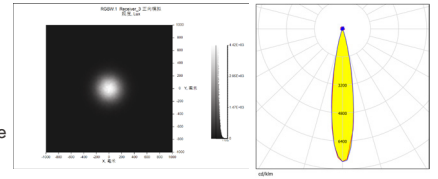

LED:LUMILEDS 5050
 角度/FWHM:20°
 光效/Efficiency:90%
 峰值强度/Peakintensity:7CD/LM
 光学面数量/LED/each optic:1
 灯光颜色/Light colour:白色/White
 所需组件/Required components:

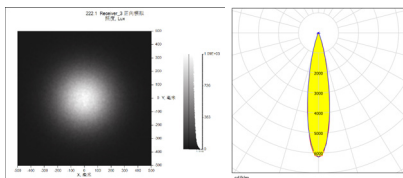

LED:NICHIA AMT149-7070
 角度/FWHM:27°
 光效/Efficiency:90%
 峰值强度/Peakintensity:4CD/LM
 光学面数量/LED/each optic:1
 灯光颜色/Light colour:白色/White
 所需组件/Required components:

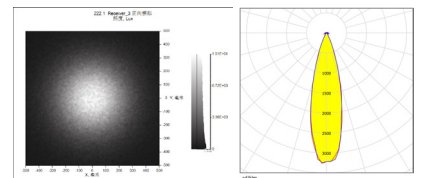

CAD

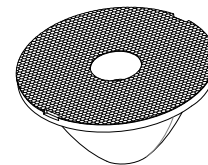
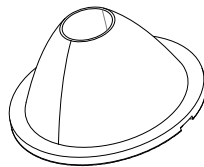
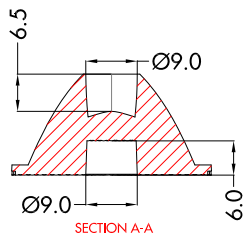
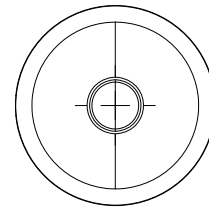
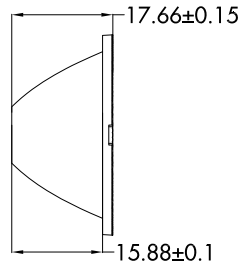
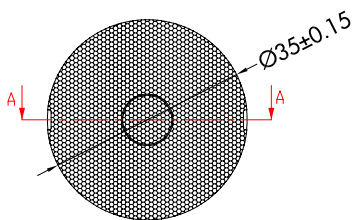

注意/NOTE:

1. 镜片表面应光滑无划痕、气泡、凹痕和黑点。

The surface of the lens should be smooth without scratches, bubbles, dents and black spots.

GENERAL TOL ERANCES ISO2768-M (UNLESS STATED) 一般公差ISO 2768-M (除非另有说明)	MATERIL 材质	PMMA	DRAWING TITLE 绘图标题	ILENS222-S35-B20-H
LINEAR/线性	0~5±0.05		5~10±0.1	10~30±0.15
ANGULAR/角度	0°~10°±1°		10°~50°±0.5°	50°~120°±0.3°

H222V-3535

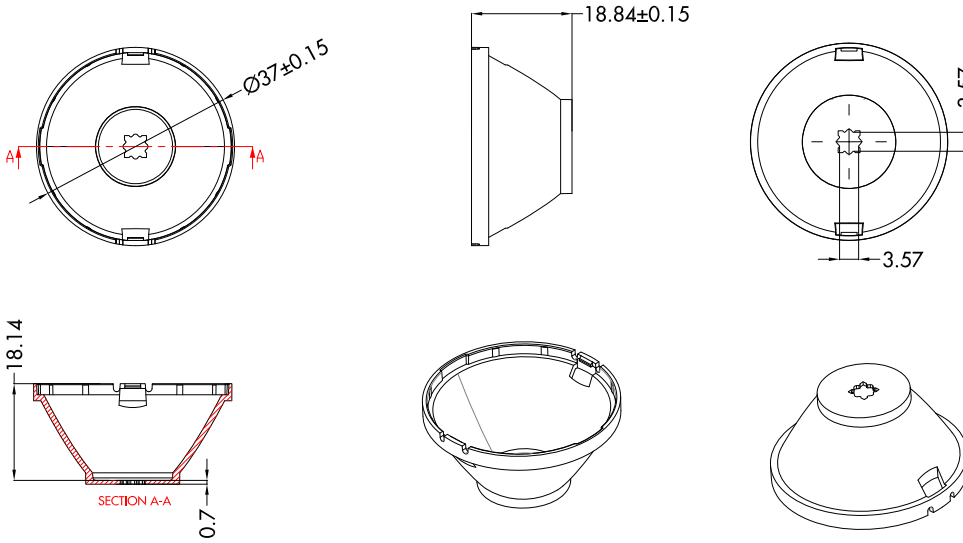

材质/MATERIAL	PC
线性/LINEAR	
0~5±0.05	
5~10±0.1	
10~30±0.15	
角度/ANGULAR	
0°~10°±1°	
10°~50°±0.5°	
50°~120°±0.3°	

H222V-5050

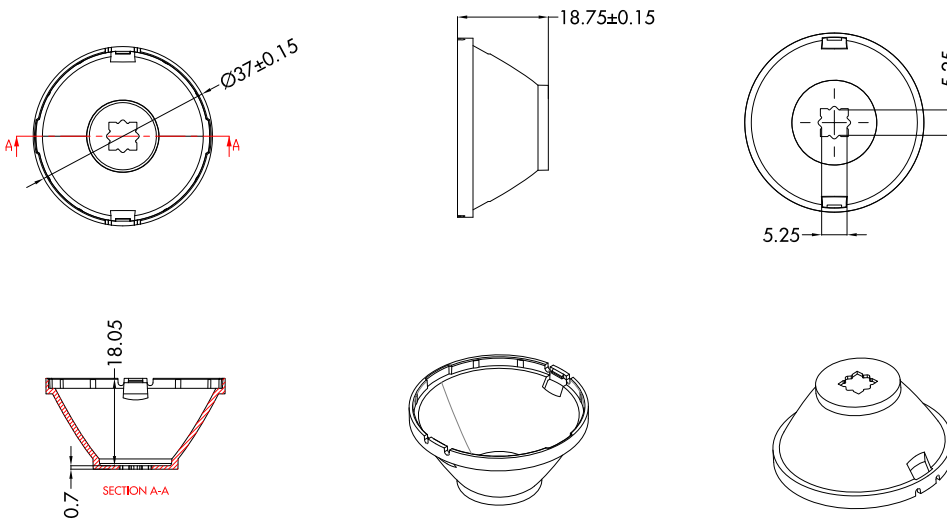

材质/MATERIAL	PC
线性/LINEAR	
0~5±0.05	
5~10±0.1	
10~30±0.15	
角度/ANGULAR	
0°~10°±1°	
10°~50°±0.5°	
50°~120°±0.3°	

H222V-P

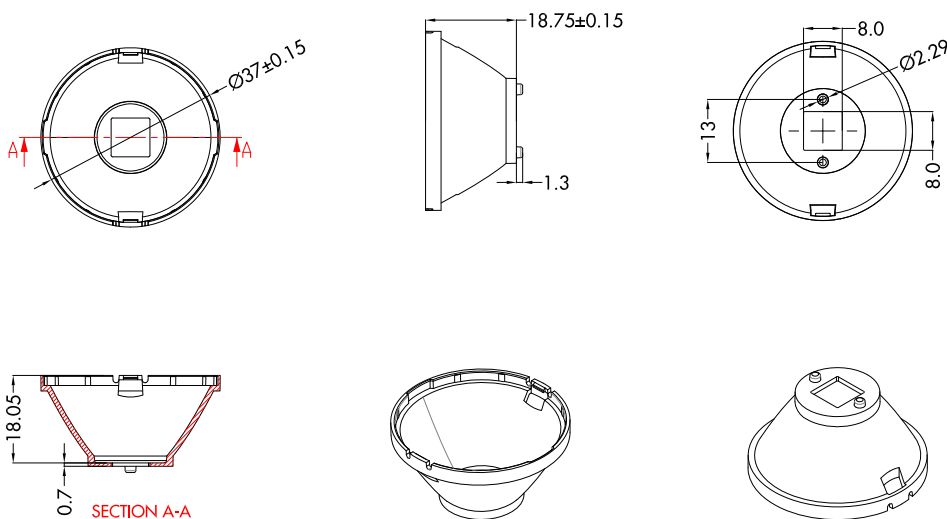

材质/MATERIAL	PC
线性/LINEAR	
0~5±0.05	
5~10±0.1	
10~30±0.15	
角度/ANGULAR	
0°~10°±1°	
10°~50°±0.5°	
50°~120°±0.3°	

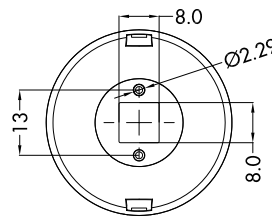
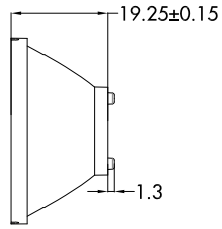
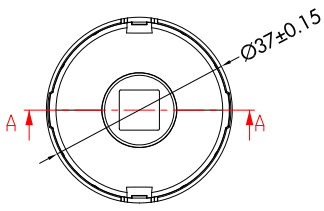

材质/MATERIAL	PC
线性/LINEAR	
0~5±0.05	
5~10±0.1	
10~30±0.15	
角度/ANGULAR	
0°~10°±1°	
10°~50°±0.5°	
50°~120°±0.3°	

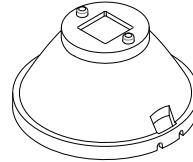
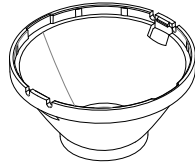
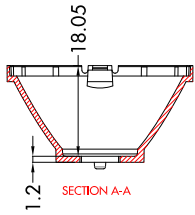

产品包装/Products Packaging

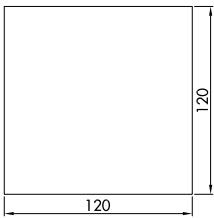

层纸
cardboard (0.4mm thickness)

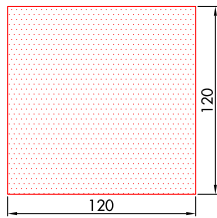

静电纸
MG tissue paper (19g/m²)

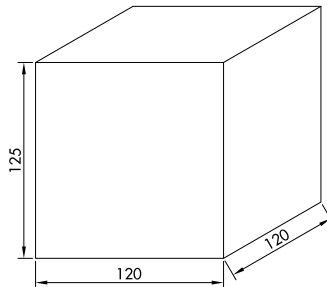

内盒
cardboard box(S)

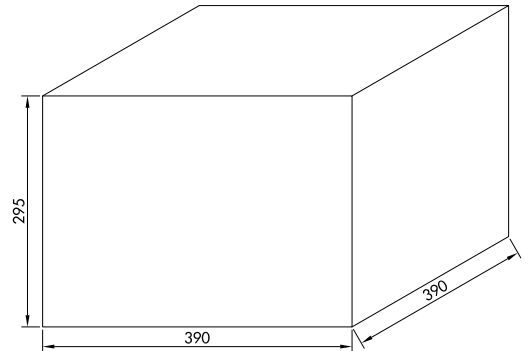

外盒
cardboard box(M) 2:1

型号/Part No.	数量/QTY
ILENS222-S35-B20-H	1134pcs
静电纸/MG tissue paper (19g/m ²)	126pcs
层纸/cardboard (0.4mm thickness)	144pcs
内盒/cardboard box (S)	18pcs
外盒/cardboard box (M)	1pcs

示意图/The schematic diagram:

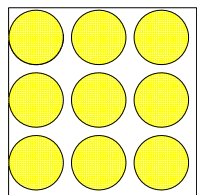

3pcs*3=9pcs

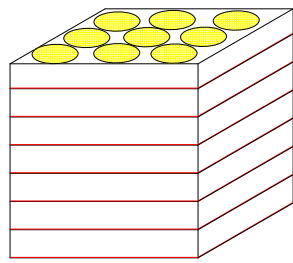

9pcs*7=63pcs

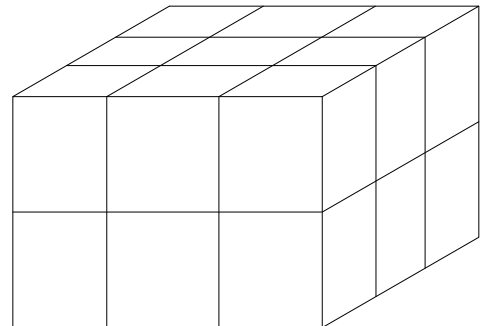

63pcs*18=1134pcs