

## 规格/TECHNICAL SPECIFICATIONS

型号/MODEL NUMBER:	I LENS65-R1812-6090-NH
透镜尺寸/LENS DIMENSIONS:	17.6*11.9*7.96MM
定位方式/FASTENING:	定位柱、贴胶/Pin or Tape
是否符合ROHS/ROHS COMPLIANT:	是/YES



### 说明/CHARACTERISTIC:

1. 透镜有多种不同的配光角度。  
The lens have multiple types beam angles.
2. 贴胶或者定位柱定位安装。  
Self-adhesive tape or pins for fix.
3. 兼容多种灯珠。  
Compatible with various lamp beads.
4. 指示照明  
Signage lighting
5. 与市面上同类镜头相比，光效更好，光斑更漂亮，兼容性更好。  
Compared with similar type lenses on the market,with better light effect ,more beautiful spot and better compatibility



ILENS65-R1812-6090-NH

实测配光/OPTICAL RESULTS (PC)

LED:CREE XPE2  
 角度/FWHM:57°89°  
 光效/Efficiency:93%  
 峰值强度/Peakintensity:0.63CD/LM  
 光学面数量/LED/each optic:1  
 灯光颜色/Light colour: 白色/White  
 所需组件/Required components:

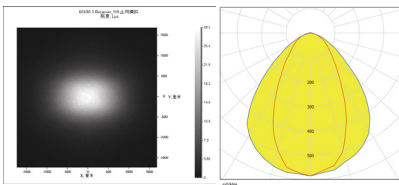

LED:CREE XPG2  
 角度/FWHM:63°95°  
 光效/Efficiency:93%  
 峰值强度/Peakintensity:0.56CD/LM  
 光学面数量/LED/each optic:1  
 灯光颜色/Light colour: 白色/White  
 所需组件/Required components:

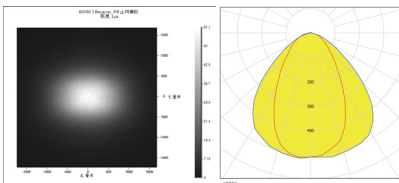

LED:LUXEON 3030 Round  
 角度/FWHM:55°91°  
 光效/Efficiency:93%  
 峰值强度/Peakintensity:0.6CD/LM  
 光学面数量/LED/each optic:1  
 灯光颜色/Light colour: 白色/White  
 所需组件/Required components:

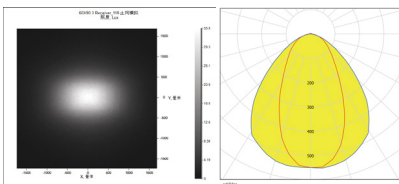

LED:LUXEON 3030 Square  
 角度/FWHM:56°92°  
 光效/Efficiency:93%  
 峰值强度/Peakintensity:0.61CD/LM  
 光学面数量/LED/each optic:1  
 灯光颜色/Light colour: 白色/White  
 所需组件/Required components:

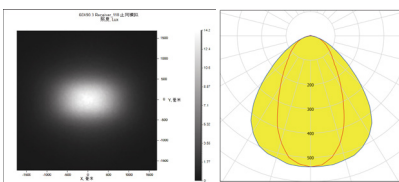

LED:LUXEON 5050 Round  
 角度/FWHM:54°86°  
 光效/Efficiency:93%  
 峰值强度/Peakintensity:0.64CD/LM  
 光学面数量/LED/each optic:1  
 灯光颜色/Light colour: 白色/White  
 所需组件/Required components:

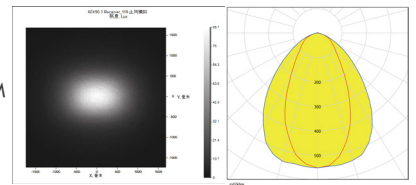

LED:SAMSUNG LH351B  
 角度/FWHM:63°96°  
 光效/Efficiency:93%  
 峰值强度/Peakintensity:0.56CD/LM  
 光学面数量/LED/each optic:1  
 灯光颜色/Light colour: 白色/White  
 所需组件/Required components:

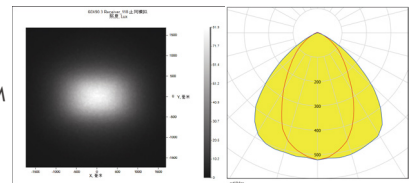

LED:SAMSUNG LM281B  
 角度/FWHM:56°91°  
 光效/Efficiency:93%  
 峰值强度/Peakintensity:0.61CD/LM  
 光学面数量/LED/each optic:1  
 灯光颜色/Light colour: 白色/White  
 所需组件/Required components:

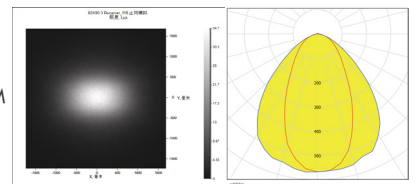

LED:OSRAM GW-PSLR31em  
 角度/FWHM:55°92°  
 光效/Efficiency:93%  
 峰值强度/Peakintensity:0.6CD/LM  
 光学面数量/LED/each optic:1  
 灯光颜色/Light colour: 白色/White  
 所需组件/Required components:

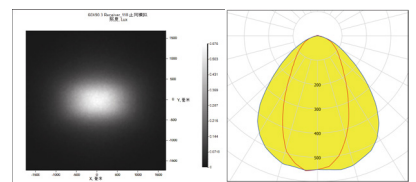

LED:CREE XPE2  
 角度/FWHM:57\*89°  
 光效/Efficiency:93%  
 峰值强度/Peakintensity:0.63CD/LM  
 光学面数量/LED/each optic:1  
 灯光颜色/Light colour:白色/White  
 所需组件/Required components:

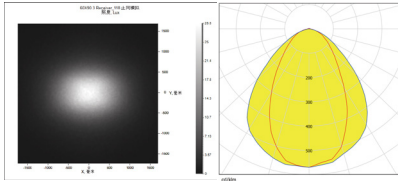

LED:CREE XPG2  
 角度/FWHM:63\*95°  
 光效/Efficiency:93%  
 峰值强度/Peakintensity:0.56CD/LM  
 光学面数量/LED/each optic:1  
 灯光颜色/Light colour:白色/White  
 所需组件/Required components:

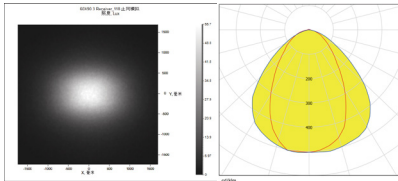

LED:LUXEON 3030 Round  
 角度/FWHM:55\*91°  
 光效/Efficiency:93%  
 峰值强度/Peakintensity:0.6CD/LM  
 光学面数量/LED/each optic:1  
 灯光颜色/Light colour:白色/White  
 所需组件/Required components:

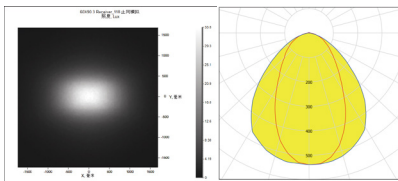

LED:LUXEON 3030 Square  
 角度/FWHM:56\*92°  
 光效/Efficiency:93%  
 峰值强度/Peakintensity:0.61CD/LM  
 光学面数量/LED/each optic:1  
 灯光颜色/Light colour:白色/White  
 所需组件/Required components:

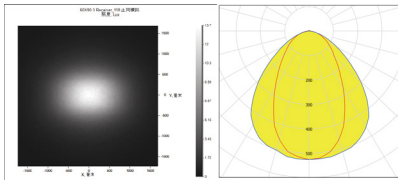

LED:LUXEON 5050 Round  
 角度/FWHM:54\*86°  
 光效/Efficiency:93%  
 峰值强度/Peakintensity:0.64CD/LM  
 光学面数量/LED/each optic:1  
 灯光颜色/Light colour:白色/White  
 所需组件/Required components:

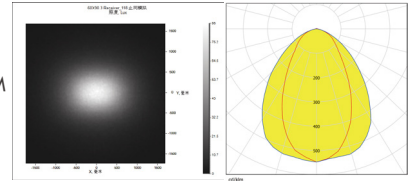

LED:SAMSUNG LH351B  
 角度/FWHM:63\*96°  
 光效/Efficiency:93%  
 峰值强度/Peakintensity:0.56CD/LM  
 光学面数量/LED/each optic:1  
 灯光颜色/Light colour:白色/White  
 所需组件/Required components:

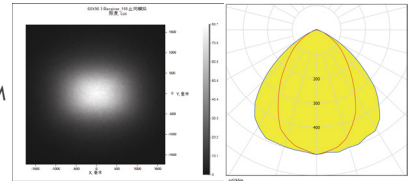

LED:SAMSUNG LM281B  
 角度/FWHM:56\*91°  
 光效/Efficiency:93%  
 峰值强度/Peakintensity:0.61CD/LM  
 光学面数量/LED/each optic:1  
 灯光颜色/Light colour:白色/White  
 所需组件/Required components:

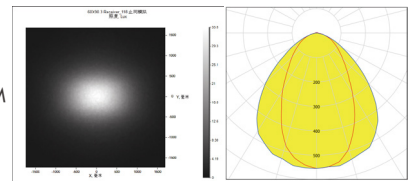

LED:OSRAM GW-PSLR31 em  
 角度/FWHM:55\*92°  
 光效/Efficiency:93%  
 峰值强度/Peakintensity:0.6CD/LM  
 光学面数量/LED/each optic:1  
 灯光颜色/Light colour:白色/White  
 所需组件/Required components:

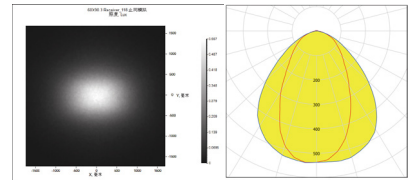

CAD

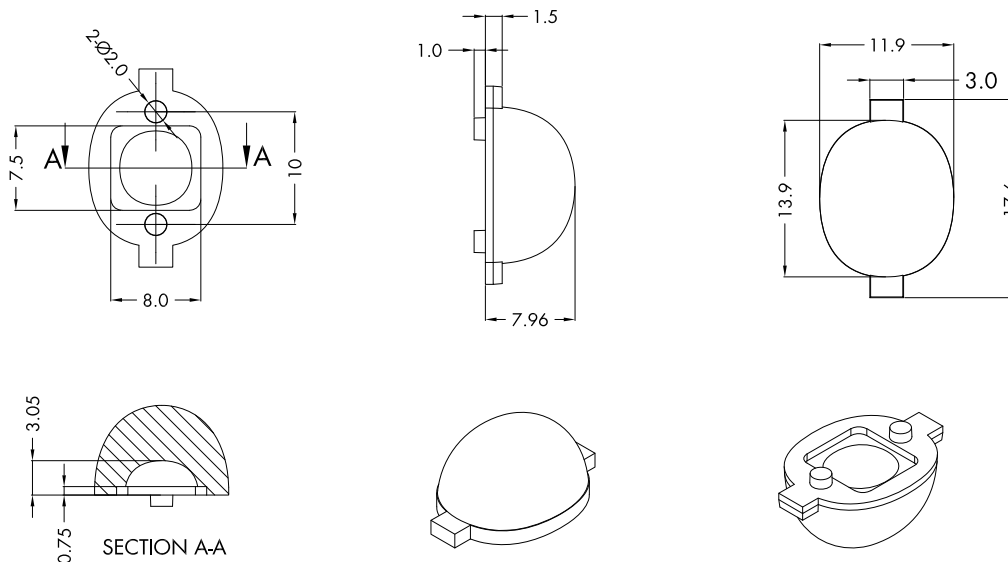

注意/NOTE:

1. 镜片表面应光滑无划痕、气泡、凹痕和黑点。

The surface of the lens should be smooth without scratches, bubbles, dents and black spots.

GENERAL TOLERANCES ISO2768-M (UNLESS STATED) 一般公差ISO 2768-M (除非另有说明)	MATERIAL 材质	PC or PMMA	DRAWING TITLE 绘图标题	I LENS65-R1812-6090-NH
LINEAR/线性	0~5±0.05		5~10±0.1	10~30±0.15
ANGULAR/角度	0°~10°±1°		10°~50°±0.5°	50°~120°±0.3°



# 产品包装/PRODUCTS PACKAGING

型号/Part No.	数量/QTY
ILENS65	21600pcs
PE袋/PE bag	1200pcs
内盒cardboard box(S)	18pcs
外盒cardboard box(M)	1pcs

示意图/The schematic diagram:



1200PCS

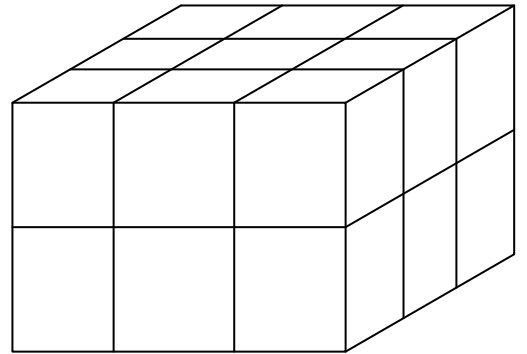
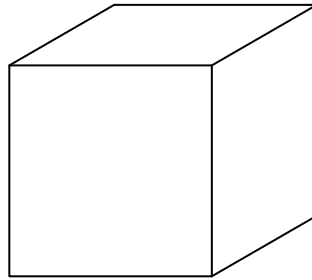

1200pcs\*18=21600pcs